

# **SX-560 Embedded Intelligent Module**

## **Developer's Reference Guide**

© 2008, 2009, 2010, 2011, 2012 Silex Technology America, Inc.. All rights reserved.  
February, 2012

Silex Technology America SPECIFICALLY DISCLAIMS THE IMPLIED WARRANTIES OF MERCHANTABILITY AND FITNESS OF THIS PRODUCT FOR A PARTICULAR PURPOSE. Silex shall not be liable for any errors contained in this manual or for any damages resulting from loss of use, data, profits, or any incidental or consequential damages arising from the use of SILEX products or services. The information contained in this documentation is subject to change without notice.

Information and descriptions contained herein are the property of Silex. Such information and descriptions may not be copied, disseminated, or distributed without the express written consent of Silex. This publication is subject to change without notice.

The software embedded in this SX-560 module includes the Linux operating system. Linux and certain other software programs used in the SX-560 are licensed under GNU GPL compatible Free Software Licenses. In compliance with these licenses, you can obtain the relevant source code at no charge by contacting Silex at support@silexamerica.com.

#### **Trademarks**

ExtendView is a trademark of Silex Technology America, Inc. All other company or product names referenced in this document may be trademarks or registered trademarks of their respective owners.

**Silex Technology America, Inc.**

[www.silexamerica.com](http://www.silexamerica.com)

Part Number 140-00192-100

Revision F

# Contents

About This Reference Guide .....	1
Safety Precautions.....	1
Emissions Disclaimer.....	1
Chapter 1: Introduction.....	2
Chapter 2 Installing the Evaluation Daughtercard .....	3
Verify Development Kit Contents.....	6
Installing the SX-560-1701 Module .....	7
Installing the SX-560-2701 Module .....	8
Monitoring Module Status .....	8
OEM Interface.....	9
Electrical Characteristics .....	10
Power Input.....	10
Power Management.....	11
Serial Ports.....	11
RS-232 Cable.....	12
Using the GPIO Special Functions.....	13
26-Pin I/O Header .....	14
LEDs and General Purpose I/O Signals .....	16
USB Host Port and Ethernet Port .....	17
Ethernet Port.....	17
Additional OEM Interface Signals .....	17
Serial Peripheral Interface .....	18
LCD Interface.....	18
OEM Interface Electrical Characteristics .....	18
Chapter 3 Configuring the SX-560 .....	19
Basic Configuration Requirements .....	19
Initial Wireless Setup .....	20
Configuration Methods .....	20
Using the ExtendView Utility to Configure the SX-560 (Ethernet Connection) .....	22
Using a Web Browser to Configure the SX-560 .....	26
Using the Internal Command Console to Configure the SX-560.....	28
Chapter 4 Using the SX-560 with Your Application .....	31
Linux Programmability .....	31
Customizing the SX-560 User Interface .....	31
Power Configuration .....	32
Serial Port Emulator.....	32
Raw TCP connection.....	33
RFC 2217 Remote Modem Control Support .....	34
ECable Mode .....	34
Print Server Mode.....	35
Console Mode Switching .....	35
AT Commands.....	35

SNMP Traps and GPIO Status .....	36
Chapter 5 Interfacing the SX-560 to the OEM Device .....	37
SX-560 Power Requirements .....	41
Installing the SX-560.....	42
Antenna Connectors .....	42
SX-560-1701 Retaining Bracket (Optional) .....	43
Regulatory Approval Requirements (SX-560-1701).....	43
Regulatory Approval Requirements (SX-560-2701).....	45
General Purpose I/O Interface.....	46
Chapter 6 Advanced Configuration .....	47
Factory Default Settings .....	47
Restoring Factory Default Settings .....	48
Modifying TCP/IP Settings.....	48
Configuring SNMP .....	51
Configuring the General Purpose I/O (GPIO) Lines .....	52
Configuring Serial Port Monitor Alert and Trap Configuration .....	64
Setting up SNMP Traps .....	65
Using AT Modem Commands .....	65
Standard AT Commands Supported.....	65
Response Codes .....	67
Using ExtendView for Bulk Configuration.....	67
Chapter 7 Product Specifications .....	68
TCP Port Connections .....	69
Appendix A Advanced Security Configuration .....	70
Appendix B Console Commands .....	73
Wireless and Network Security Commands .....	73
Port Commands.....	78
Server Information Commands.....	79
Service Commands .....	80
SNMP Commands .....	82
String Commands .....	83
TCP/IP Commands.....	84
Power Configuration Commands.....	88
Miscellaneous Commands .....	89
Help Commands .....	89
Appendix C SX-560-1701 Antenna Information .....	90
Antenna Cable Drawings and Specifications .....	90
Antenna Drawings and Specifications .....	91
Appendix D SX-560-2701 Antenna Information .....	93
Antenna Specifications .....	93
Appendix E Firmware Update Procedures.....	94
Appendix F GNU/Linux Open Source and Programming .....	96
Appendix G Silex Contact Information .....	97

# Figures

Figure 1 SX-560-1701 top and bottom view .....	2
Figure 2 SX-560-2701 top and bottom view .....	2
Figure 3 Installing SX-560-1701 Module in Evaluation Daughtercard .....	3
Figure 4 Installing SX-560-2701 Module in Evaluation Daughtercard .....	4
Figure 5 SX-560 Module Inserted in Daughtercard .....	7
Figure 6 SX-560 Module Inserted in Daughtercard .....	8
Figure 7 Serial Port DB-9 Connector .....	11
Figure 8 RS-232 Cable Pinouts .....	13
Figure 9 GPIO Special Functions Jumpers (Example Configuration) .....	14
Figure 10 USB/Ethernet Jumper Settings .....	17
Figure 11 Using spacers with SX-560 WLAN model .....	42
Figure 12 Main and Auxiliary Antenna Connectors .....	42
Figure 13 Retaining Bracket .....	43
Figure 14 TCP/IP Window .....	48
Figure 15 Change Password Window .....	49
Figure 16 Advanced TCP/IP Configuration Window .....	50
Figure 17 SNMP Configuration .....	52
Figure 18 Antenna Cable Assembly .....	90

# Tables

Table 1 Development Kit Contents .....	6
Table 2 Status Monitors .....	9
Table 3 OEM Interface Pinout .....	9
Table 4 OEM Interface Signal Descriptions .....	10
Table 5 DB-9 Pinouts for RS-232 Mode .....	11
Table 6 Logical Serial Port 1 Signal Descriptions .....	12
Table 7 RS-232 Cable Pinout Description .....	13
Table 8 GPIO Special Functions .....	13
Table 9 26-Pin I/O Header .....	14
Table 10 General Purpose I/O Signal Descriptions .....	15
Table 11 LED and GPIO Descriptions .....	16

Table 12 OEM Signal Parameter Descriptions .....	18
Table 13 OEM Interface Pinout .....	40
Table 14 OEM Interface Signal Descriptions .....	40
Table 15 Antenna Connector Types .....	43
Table 16 GPIO Interface.....	46
Table 17 Factory Default Settings .....	47
Table 18 TCP/IP Settings .....	49
Table 19 TCP/IP Configuration Settings.....	50
Table 20 SNMP Commands.....	51
Table 21 GPIO General Commands .....	53
Table 22 GPIO Trigger Commands.....	56
Table 23 GPIO Transmit Commands .....	58
Table 24 GPIO Data Commands.....	59
Table 25 E-GPIO TCP Monitor Commands .....	60
Table 26 GPIO SNMP Management .....	62
Table 27 Port Monitor Alert Commands .....	64
Table 28 AT Commands.....	65
Table 29 Extended AT Commands .....	67
Table 30 Response Codes .....	67
Table 31 Product Specifications .....	68
Table 32 Radio Specifications .....	68
Table 33 TCP Port Connections.....	69
Table 34 Network Commands .....	73
Table 35 Port Commands.....	78
Table 36 Server Information Commands .....	79
Table 37 Service Commands .....	80
Table 38 SNMP Commands.....	82
Table 39 String Commands.....	83
Table 40 TCP/IP Commands.....	84
Table 41 Power Configuration .....	88
Table 42 Miscellaneous Commands .....	89
Table 43 Electrical Performance .....	91
Table 44 Electrical Specifications.....	92

## About This Reference Guide

This reference guide provides detailed specifications, diagrams and additional information required to integrate the SX-560 embedded intelligent module in a product. The intended audiences are the developers and engineers responsible for the integration of the module in another product.

### Safety Precautions

- To prevent damage to the SX-560 module's electronic circuit components, follow established ESD practices and procedures for handling static-sensitive devices. All ESD-sensitive components must be stored and shipped in ESD-conductive bags or bubble-wrap and labeled as such using the standardized ESD adhesive warning label.
- Ethernet electrical wiring must be at least 6 feet from bare power wiring or lightning rods and associated wires, and at least 6 inches from other types of wire (antenna wires, doorbell wires, wires from transformers to neon signs), steam or hot water pipes, and heating devices.
- Protectors and grounding wire placed by the service provider must not be connected to, removed, or modified by the customer.

### Emissions Disclaimer

Final emission certification per FCC, CE and other agency requirements are the responsibility of the OEM using any printed circuit assemblies or other items used in this developer's kit in their saleable packaged product.

# Chapter 1: Introduction

The SX-560 embedded intelligent module provides a complete solution for integrating wireless networking technology into virtually any OEM product that has an RS-232 or UART serial port, or a USB V1.1 port. It has a main printed circuit board that contains a processor, memory, flash memory, three (3) serial ports (one dedicated for use as a console) plus a USB V1.1 host port and an SPI port. There are two variants of the SX-560 module. On the SX-560-1701, the wireless LAN functionality is provided through an SDIO 802.11a/b/g radio daughtercard based on the Atheros AR6001XL chipset. On the SX-560-2701, the wireless LAN functionality is provided through an SDIO card based on the AR6002XL chipset. The SX-560 measures 49.6 x 34.3 x 9.65 mm (1.95 x 1.35 x 0.38 inches).

The SX-560-6900 Evaluation Daughtercard is available to expedite the development process. This board includes an RJ45 Ethernet connector, three 9-pin serial connectors, one USB connector, header connectors for all major I/O, power supply, antenna, cables, and software.

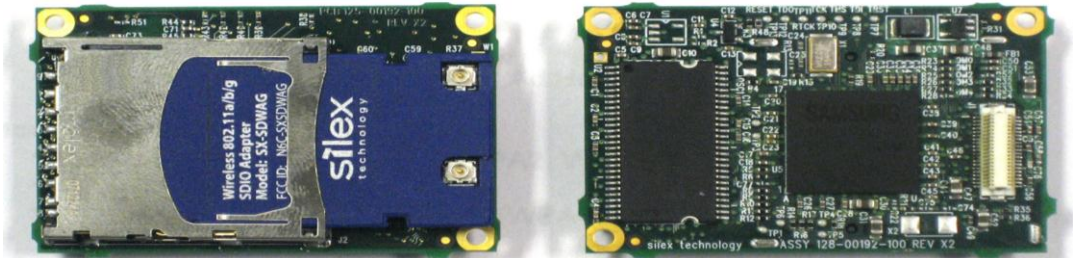

Figure 1 SX-560-1701 top and bottom view

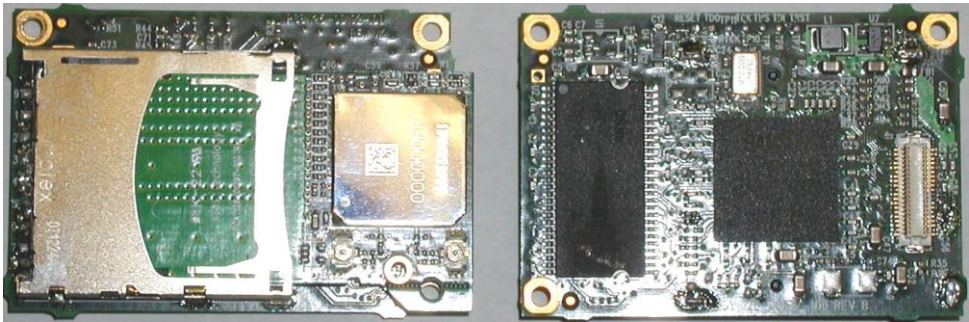

Figure 2 SX-560-2701 top and bottom view



## Chapter 2 Installing the Evaluation Daughtercard

The SX-560-6900 Evaluation Daughtercard is designed to help you in the development of the necessary hardware and software required to use the SX-560 module. It includes I/O connectors, cables, and power supply in an easy-to-use package. The SX-560-1701 Module is installed in the Evaluation Daughtercard as shown in Figure 3. The SX-560-2701 module is installed as shown in Figure 4

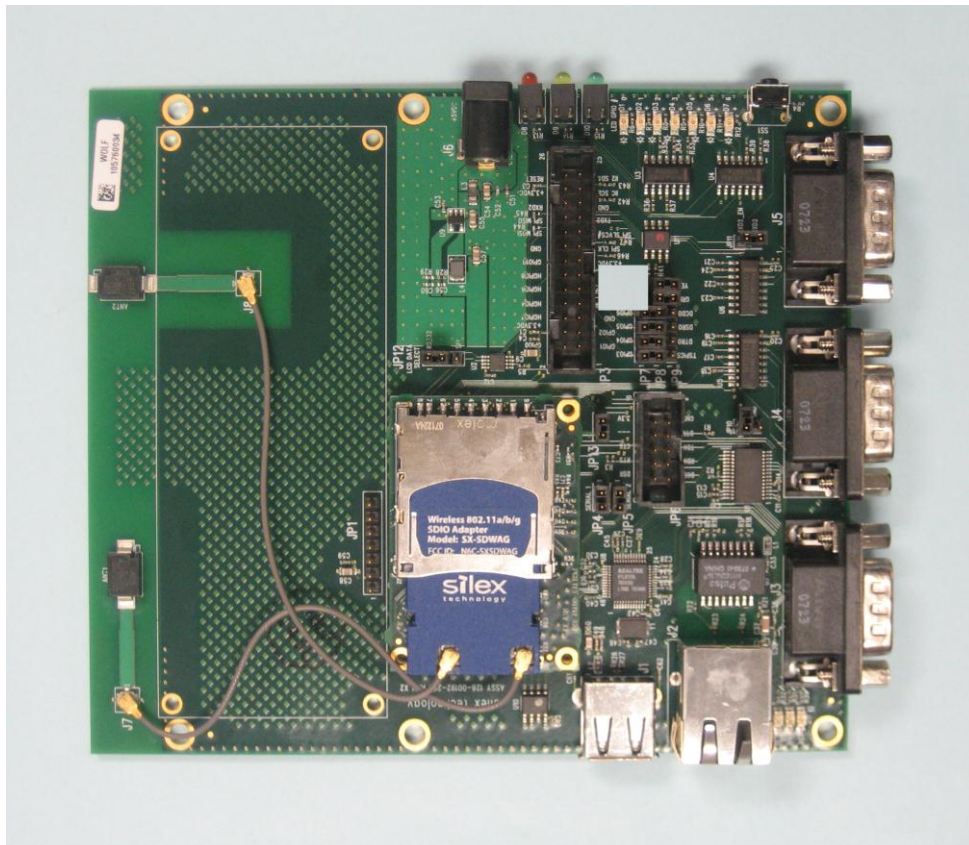
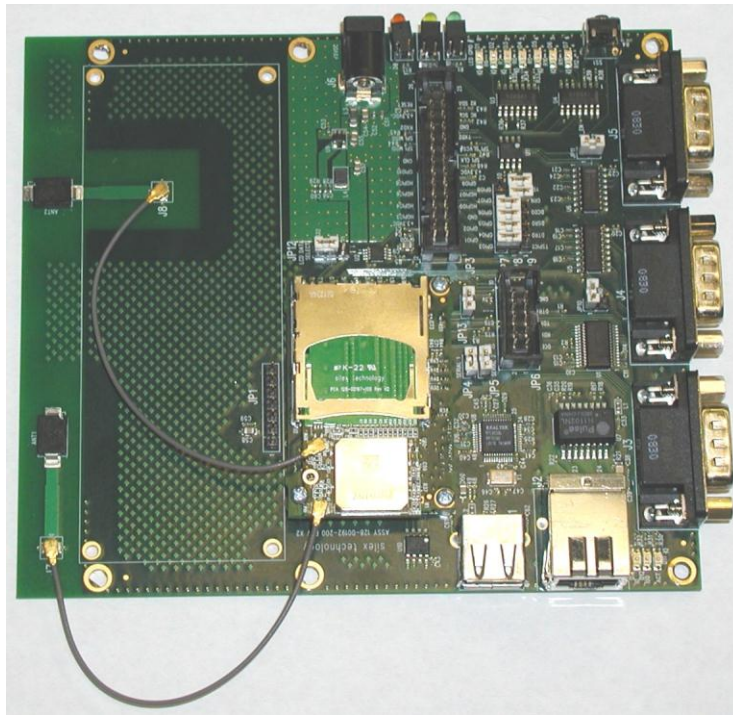

Figure 3 Installing SX-560-1701 Module in Evaluation Daughtercard



**Figure 4 Installing SX-560-2701 Module in Evaluation Daughtercard**

The Evaluation Daughtercard makes it easy to connect to the SX-560 for test and development by providing the following:

- Three (3) 9-pin connectors and one (1) 10-pin header for connecting the SX-560 serial ports
- One (1) 26-pin header for connecting GPIOs, SPI, power, and ground
- One (1) RJ45 Ethernet connector
- One power jack
- 3 LEDs for displaying the power and network status
- 7 LEDs for monitoring the GPIO signals
- One (1) Test Button for printing configuration data and resetting the SX-560 to factory defaults
- One (1) 18-pin header for selecting GPIOs as modem controls
- Two (2) built-in bead antennas
- Power supply and mounting hardware

The locations of the major Evaluation Daughtercard connectors and headers are shown in the diagram below.



## Verify Development Kit Contents

The SX-560-6900 Evaluation Module Development Kit consists of the components listed in Table 1. Please ensure that all materials listed are present and free from visible damage or defects before proceeding. If anything appears to be missing or damaged, please contact Silex.

**Table 1 Development Kit Contents**

Description
SX-560-6900 Evaluation Daughtercard
5 VDC 1 Amp Power Supply
AC Power Cord for US
AC Power Cord for Europe
2 x Serial Null Modem Cables
2 x U.FL/I-PEX to U.FL/I-PEX 100mm (4") Antenna Cable
Plastic bag containing: <ul style="list-style-type: none"><li>▪ 4 x Rubber Feet with Adhesive</li><li>▪ 3 M2 x 10mm screws</li><li>▪ 3 M2 nuts</li><li>▪ 3 4mm nylon spacers</li><li>▪ 1 M2 x 14mm screw</li><li>▪ 1 2.8mm nylon spacer</li></ul>

## Installing the SX-560-1701 Module

To install the SX-560-1701 module in the SX-560-6900 Evaluation Daughtercard:

1. Using the 40-pin OEM interface header (JP2), plug the SX-560-1701 Module in the SX-560-6900 Evaluation Daughtercard and secure with screws, nuts and spacers (you may optionally use the metal retaining bracket to secure the radio card and to reduce electromagnetic interference; refer to Chapter 5 for information on using this bracket). Important: *The spacers MUST be installed to avoid potential damage to the boards.*

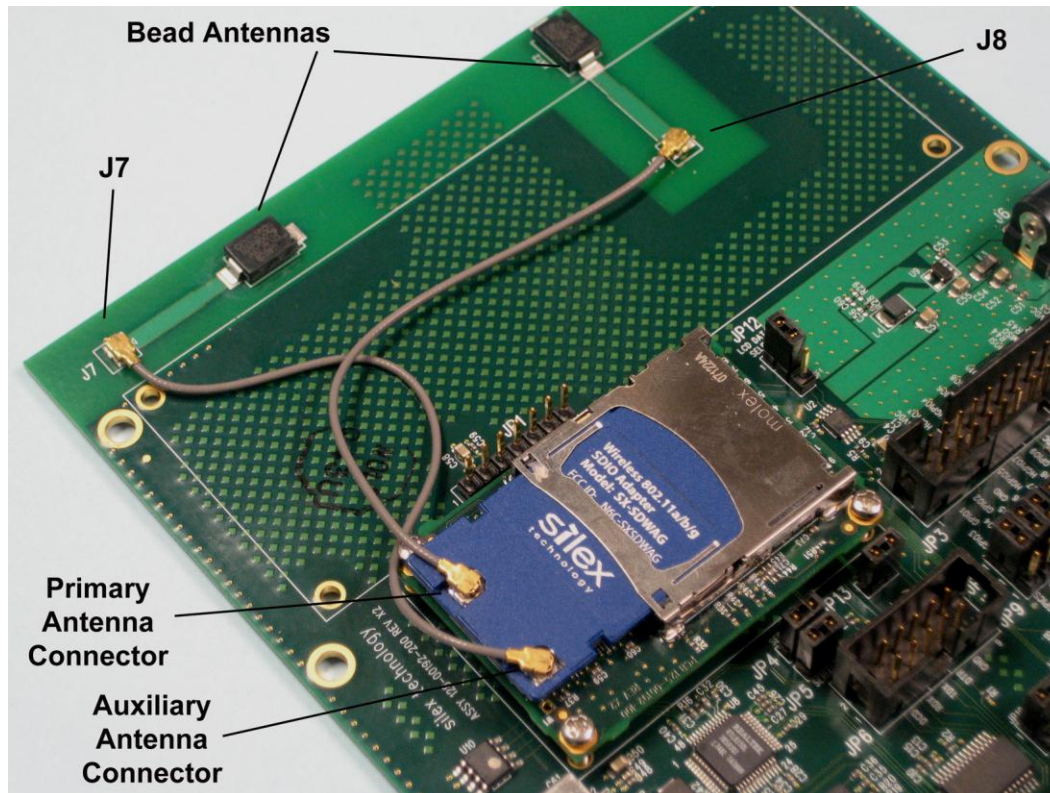

Figure 5 SX-560 Module Inserted in Daughtercard

2. The Evaluation Daughtercard includes both on-board bead antennas and external antennas. Use the included U.FL to U.FL cables with the bead antennas or the U.FL to RP-SMA cables with the external antennas. Plug the main antenna cable into the Main Antenna Connector on the card (see Figure 3). Plug the auxiliary antenna cable into the Auxiliary Antenna Connector (the auxiliary antenna improves radio reception, but is not required for operation).
3. If you are using the on-board bead antennas, connect the other end of the antenna cable(s) into either of the built-in bead antenna connectors (J7 and J8) as shown in figure 3. If you are using the external antennas, connect the RP-SMA end of the antenna cable(s) to the external antenna(s).
4. Connect one serial null-modem cable from the Serial Port 3 DB-9 connector (J5) on the Evaluation Daughtercard to a serial port on a personal computer or laptop (the computer's serial port must be set to 115.2Kbps, no parity, no flow control, and 8-bit character size). The PC or laptop acts as a console port for command line configuration and monitoring.
5. If you want to use an Ethernet LAN connection for the initial configuration of the SX-560 (recommended), plug a category 5 Ethernet cable into the RJ-45 jack. The Ethernet interface has Auto-MDIX that automatically detects and configures itself for either a straight-thru or crossover Ethernet cable.

## Installing the SX-560-2701 Module

To install the SX-560-2701 module in the SX-560-6900 Evaluation Daughtercard:

1. Using the 40-pin OEM interface header (JP2), plug the SX-560-2701 Module in the SX-560-6900 Evaluation Daughtercard and secure with screws, nuts and spacers. The longer screw (14mm) and short spacer (2.5mm) are used with the hole in the SDIO radio card which lines up with the corresponding hole in the SX-560 main board. **Important: The spacers MUST be installed to avoid potential damage to the boards.**

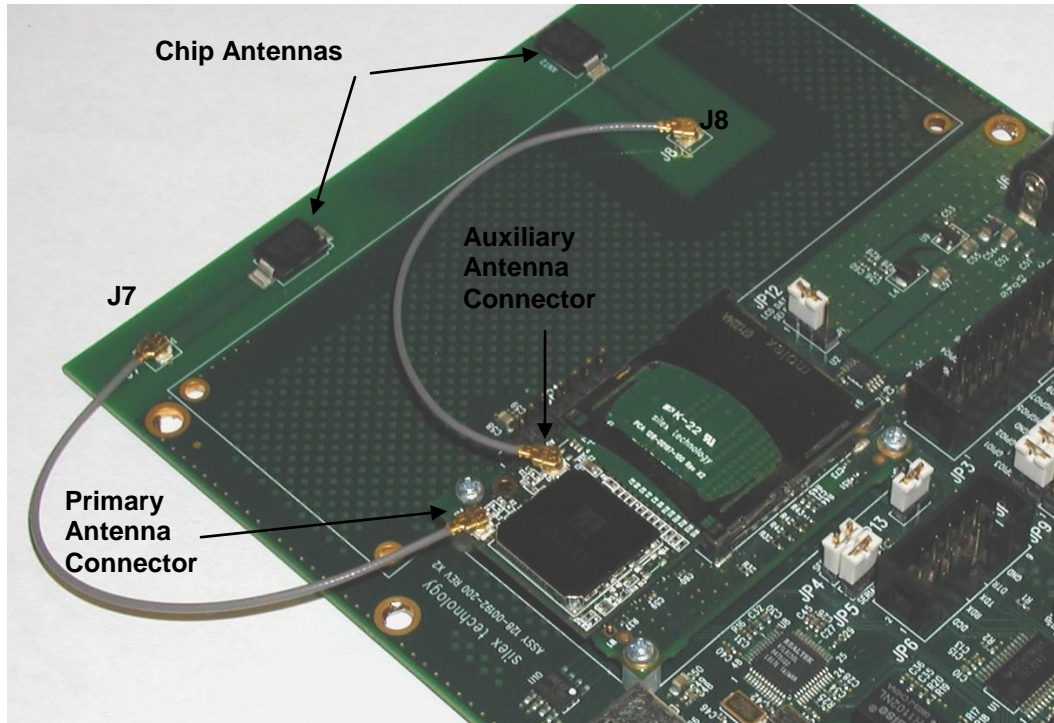

Figure 6 SX-560 Module Inserted in Daughtercard

2. The Evaluation Daughtercard includes on-board chip antennas. Use the included U.FL to U.FL cables. Plug the main antenna cable into the Primary Antenna Connector on the card (see Figure 3). Plug the auxiliary antenna cable into the Auxiliary Antenna Connector (the auxiliary antenna improves radio reception, but is not required for operation).
3. If you are using the on-board chip antennas, connect the other end of the antenna cable(s) into either of the built-in chip antenna connectors (J7 and J8) as shown in figure 3.
4. Connect one serial null-modem cable from the Serial Port 3 DB-9 connector (J5) on the Evaluation Daughtercard to a serial port on a personal computer or laptop (the computer's serial port must be set to 115.2Kbps, no parity, no flow control, and 8-bit character size). The PC or laptop acts as a console port for command line configuration and monitoring.
5. If you want to use an Ethernet LAN connection for the initial configuration of the SX-560 (recommended), plug a category 5 Ethernet cable into the RJ-45 jack. The Ethernet interface has Auto-MDIX that automatically detects and configures itself for either a straight-thru or crossover Ethernet cable.

## Monitoring Module Status

You can monitor the module status using the yellow, green and orange LED status indicators on the Evaluation Daughtercard. Table 2 defines the default functions of the LED status indicators.

**Table 2 Status Monitors**

Function	State	Status
Power Orange (D8)	On	The module is receiving power
	Off	The module is not receiving power
	Blinking	Firmware update is in progress ( <b>Important:</b> <i>Do not power off the module during the update process</i> )
Network Status Yellow (D9)	Yellow On	Wireless connection established

## OEM Interface

The OEM interface is a 40-pin header (JP2) that is used to connect the SX-560 module to the SX-560-6900 Evaluation Daughtercard. It will also serve as the primary means of communications between the SX-560 and your OEM device (refer to Chapter 5 for information on using this header to connect with your device).

Table 3 shows the OEM interface pinout for the Evaluation Daughtercard. Table 4 shows the OEM interface signal descriptions. Please note that the OEM interface signals are not directly accessible from the OEM header when the Evaluation Daughtercard is used. Rather, these signals are available through convenient connectors on the Evaluation Daughtercard, such as the 26-pin I/O Header and the 9-pin serial connectors. These connectors are described later in this chapter.

All input and output signals, except the differential signals, are 0 to 3.3 V logic signals.

**Table 3 OEM Interface Pinout**

PIN	SIGNAL	PIN	SIGNAL
1	RESET-	2	GPIO_0
3	GPIO_1	4	GPIO_2
5	GROUND	6	+3.3VDC
7	GPIO_3	8	GPIO_4
9	GPIO_5	10	GPIO_6
11	GPIO_7	12	GPIO_8
13	GPIO_9	14	TXD0
15	GPIO_10	16	CTS0-
17	GROUND	18	+3.3VDC
19	USB+	20	RTS0-
21	USB-	22	RXD0
23	+3.3VDC	24	GROUND
25	SPI_CS-	26	TXD1
27	SPI_CLK	28	CTS1-
29	GROUND	30	+3.3VDC
31	SPI_MOSI	32	RTS1-
33	SPI_MISO	34	RXD1
35	+3.3VDC	36	GROUND
37	IIC_SDC	38	TXD2
39	IIC_SDA	40	RXD2

**Table 4 OEM Interface Signal Descriptions**

Signal	Pin	Type	Description
GPIO_0, GPIO_1, GPIO_2, GPIO_3, GPIO_4, GPIO_5, GPIO_6, GPIO_7, GPIO_8, GPIO_9, GPIO_10	2, 3, 4, 7, 8, 9, 10, 11, 12, 13, 15	Input/Output	General Purpose Input/Output Signals 0-10, User defined (GPIO_10 is normally used for the Test Button and GPIO8-GPIO10 are normally used for the status LEDs)
RXD0	22	Input	Serial Port 1 Receive Data
TXD0	14	Output	Serial Port 1 Transmit Data
RTS0-	20	Output	Serial Port 1 Request To Send
CTS0-	16	Input	Serial Port 1 Clear to Send
RXD1	34	Input	Serial Port 2 Receive Data
TXD1	26	Output	Serial Port 2 Transmit Data
RTS1-	32	Output	Serial Port 2 Request To Send
CTS1-	28	Input	Serial Port 2 Clear to Send
RXD2	40	Input	Console Port Receive Data
TXD2	38	Output	Console Port Transmit Data
USB+, USB-	19, 21	Input/Output	USB V1.1 Host Interface
SPI_CS-	25	Input	Serial Peripheral Interface Chip Select (low-true) Slave Mode
SPI_MOSI	31	Output	Serial Peripheral Interface Data Out
SPI_MISO	33	Input	Serial Peripheral Interface Data In
SPI_CLK	27	Output	Serial Peripheral Interface Clock
IIC_SCL	37	Input/Output	Inter-IC Bus (IIC) Clock
IIC_SDA	39	Input/Output	Inter-IC Bus (IIC) Data
RESET-	1	Input/Output	Open-Drain with Pull-up on SX-560
+3.3VDC	6,18, 23, 30, 35	Power	Power VCC Input
GND	5,17, 24, 29, 36	Power	Power Ground

## Electrical Characteristics

The power requirements, port pinouts, GPIO characteristics, cable connections and wireless operational modes are described below.

### Power Input

Power to the SX-560 Module and the SX-560-6900 Evaluation Daughtercard is supplied through the power jack, located at J6, at +5VDC  $\pm 10\%$ . Use the included power supply or an equivalent +5VDC power supply with a minimum of 1 amp capacity.

Power of +3.3VDC  $\pm 5\%$  is supplied to the SX-560 Module via the I/O header, JP13.



## Power Management

The SX-560 power consumption is typically 280mA for wireless-to-serial usage, with a peak consumption is 400mA @ 3.3V. In powersave mode (refer to Chapter 4 for more information) with the SX-560 connected wirelessly to an access point, the consumption is 60mA while idling and an average of about 73mA including wakenings to answer the beacon poll.

The above numbers assume that the only active connections are the 802.11 wireless interface and the serial interface (for example, there are no connections to the GPIOs). Power consumption specifications are subject to change; contact Silex for more information.

## Serial Ports

Standard serial RS-232 signals are available on the DB-9 male connectors J3, J4 and J5 for Serial Ports 1, 2 and 3 (Serial Port 3 is dedicated as a console port, while Serial Port 2 can be set as either a console port or an I/O port), as shown in Figure 7. Serial Ports 1 and 2 include the RTS and CTS modem signals for hardware flow control, and Serial Port 1 can also support DCD, DTR, and DSR by setting the appropriate jumpers on the JP9 header (see the *Using the GPIO Special Functions* section later in this chapter). Serial Port 3 does not support any modem signals, and is fixed for operation at 115.2Kbps, no parity, no flow control, and 8-bit character size.

The DB-9 connectors use industry-standard PC-compatible pinouts as shown below:

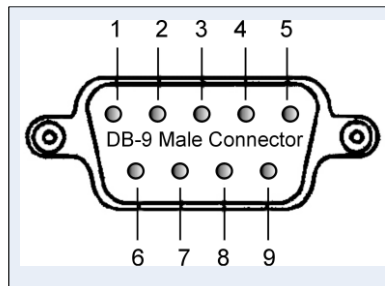

Figure 7 Serial Port DB-9 Connector

Table 5 DB-9 Pinouts for RS-232 Mode

DB-9	RS-232 Signal	Type
1	DCD	Input Enabled via JP9 header (Serial Port 1 only)
2	RXD	Input
3	TXD	Output
4	DTR	Output Enabled via JP9 header (Serial Port 1 only)
5	Ground	
6	DSR	Input Enabled via JP9 header (Serial Port 1 only)
7	RTS	Output (not supported on Serial Port 3)

DB-9	RS-232 Signal	Type
8	CTS	Input (not supported on Serial Port 3)
9	NC	

Serial Port 1 can also be accessed using logic signals via a 10-pin header located at JP6. If you want to use this header, you must place a jumper on the 2-pin header at JP10 to disable the RS-232 transceiver. The pinouts are as follows:

**Table 6 Logical Serial Port 1 Signal Descriptions**

Pin	Signal	Input/Output	Pin	Signal	Input/Output
1	DCD	Input Enabled via JP9 header	2	DSR	Input Enabled via JP9 header
3	RXD	Input	4	RTS	Output
5	TXD	Output	6	CTS	Input
7	DTR	Output Enabled via JP9 header	8	No Connect	
9	GND		10	3.3V	

All signals are 0 to 3.3 V logic signals.

The console port (Serial Port 3) can be also be accessed via the 26-pin I/O header pin headers (pin 19 for TxD and pin 22 for RxD). The console port is normally set to use the DB-9 connector; to use the 26-pin I/O header, remove the jumper on the header at JP11 so that two sources are not driving the RXD2 signal.

Note that Serial Port 3 is dedicated for use as a console port for configuring the SX-560. Serial port 3 is always set for operation at 115.2Kbps, 8 bit character size, no parity, and no flow control.

Serial Port 2 is set by default for console operation at 115.2Kbps, 8-bit characters, no parity, and no flow control. This port can be set as a second I/O port using the SET PORT S2 CONSOLE DISABLE console command.

## RS-232 Cable

The supplied DB-9 female-to-female null modem cable is wired as shown below. The pinouts are compatible with a standard PC 9-pin serial connector, so this cable can be used to directly connect a PC to Serial Port 3 for use as a console terminal to configure the SX-560. It can also be used to connect many types of OEM serial devices to Serial Port 1 or Serial Port 2, provided that these devices use PC-compatible 9-pin connectors.

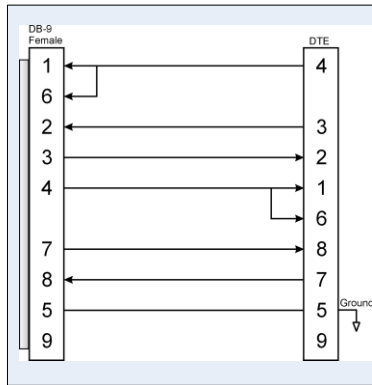

**Figure 8 RS-232 Cable Pinouts**

**Table 7 RS-232 Cable Pinout Description**

Pin	Description
1	DCD (Data Carrier Detect) Input*
6	DSR (Data Set Ready) Input*
2	RxD (Receive Data) Input
3	TxD (Transmit Data) Output
4	DTR (Data Terminal Ready) Output*
7	RTS (Request To Send) Output*
8	CTS (Clear To Send) Input*
5	Ground

\*Note: Serial Port 1 (J3) supports all signals. Serial Port 2 (J4) supports RxD, TxD, RTS, and CTS. Serial Port 3 (J5; dedicated console port) supports RxD and TxD only.

### Using the GPIO Special Functions

Six of the General Purpose I/Os (GPIOs) can be configured for either user-defined operations or for GPIO for special functions. These special functions are summarized in the following table:

**Table 8 GPIO Special Functions**

	Special Function (default setting)	Description
GPIO_3	TSPICS	Enable SPI temperature sensor
GPIO_4	DTR0	Serial Port 1 DTR modem signal
GPIO_5	DSR0	Serial Port 1 DSR modem signal
GPIO_6	DCD0	Serial Port 1 DCD modem signal
GPIO_7	GRN	Green status LED (D10)
GPIO_8	YEL	Yellow status LED (D9)

The mode of operation for each of the GPIOs can be set by installing jumpers between headers JP7 and JP8 for GPIO operation, or between headers JP8 and JP9 for special function operation (all of the special functions are enabled by default). For example, in the follow diagram, GPIO\_3 is enabled for SPI temperature sensor, while GPIO\_4 is enabled as the DTR signal (DTR0) for Serial Port 1. The GPIO\_5 through GPIO\_8 are used as normal GPIOs in this example.

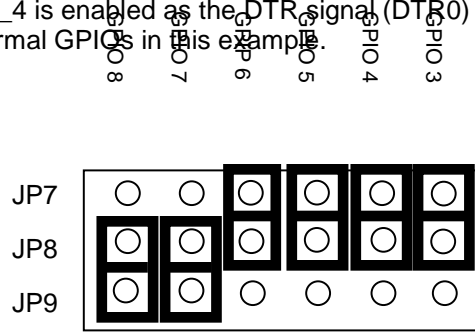

**Figure 9 GPIO Special Functions Jumpers (Example Configuration)**

The GPIOs are accessed via header JP3 as described in the next section. You can set and read the GPIO state, and set SNMP traps based on the GPIO state as described in Chapter 6 of this manual.

## 26-Pin I/O Header

The I/O Header, located at JP3, is a 26-pin interface for connecting to the SX-560 GPIO and SPI interfaces. It also provides a direct way of connecting to the SX-560 console interface using 3.3V logic levels rather than the DB-9 RS-232 connector.

The GPIOs, located on JP3, can be used for controlling or monitoring OEM functions. External pull-ups are recommended for customization.

**NOTE: GPIO\_10 is fixed as a switch input (Test Button) and GPIO\_9 is fixed as an LED output (power on/off).**

**Table 9 26-Pin I/O Header**

Pin	Signal	Selectable	Pin	Signal	Selectable
1	GPIO_1		2	GPIO_0	
3	GPIO_2		4	3.3V	
5	GND		6	HGPIO_3	Via JP7
7	HGPIO_5	Via JP7	8	HGPIO_4	Via JP7
9	HGPIO_7	Via JP7	10	HGPIO_6	Via JP7
11	GPIO_9		12	HGPIO_8	Via JP7
13	3.3V		14	GPIO_10	
15	SPI CLK		16	GND	
17	SPI SLVCS-		18	SPI MOSI	
19	TXD2		20	SPI MISO	
21	GND		22	RXD2	

Pin	Signal	Selectable	Pin	Signal	Selectable
23	IIC SCL		24	3.3V	
25	IIC SDA		26	RESET-	

As discussed in the previous section, GPIOs 3 through 8 are set by default for special functions such as modem controls. To use GPIOs 3 through 8 as normal GPIOs, you must place a jumper between JP7 and JP8 for the specific GPIO as described in the previous section. GPIO 2 can also have a special function if SPI mode is selected for the LCD display via header JP12 as described in the *LCD Interface* section later in this chapter.

**Table 10 General Purpose I/O Signal Descriptions**

Silex	S3C2412	I/O	Special Function
GPIO_0	GPF 0	O	
GPIO_1	GPF 1	O	
GPIO_2	GPF 2	O	Special function SPI_CS- for LCD display
GPIO_3	GPF 3	O	Special function TEMP_CS SPI temperature sensor enable
GPIO_4	GPF 4	O	Special function, nDTR0
GPIO_5	GPF 5	I	Special function, nDSR0
GPIO_6	GPF 6	I	Special function, nDCD0
GPIO_7	GPF 7	O	Special function, nLED_3; wired link
GPIO_8	GPG 5	O	Special function, nLED_2; wireless link
GPIO_9	GPG 6	O	nLED_1; power on/status*
GPIO_10	GPG 7	I	Switch Input; 1 = off, 0 = switch depressed*

\*The functionality of GPIO\_9 and GPIO\_10 cannot be changed by the user.

## LEDs and General Purpose I/O Signals

The LEDs are connected to the 10 GPIOs for easy viewing of signal activity. The first 7 GPIOs drive the first 7 LEDs, D1 to D7 (these LEDs indicate the status of the GPIOs). GPIOs 7 to 9 drive LEDs D8 to D10. Logic 0 and 0 volts on GPIO\_x illuminates the LED.

**Table 11 LED and GPIO Descriptions**

<b>GPIO</b>	<b>LED</b>
GPIO_0	D1
GPIO_1	D2
GPIO_2	D3
GPIO_3	D4
GPIO_4	D5
GPIO_5	D6
GPIO_6	D7
GPIO_7	D10 green LED
GPIO_8	D9 yellow LED
GPIO_9	D8 orange LED

## USB Host Port and Ethernet Port

The USB V1.1 host port, located on J1, can be used to connect standard Full Speed (12Mbps) or Low Speed (1.5Mbps) USB devices. High Speed (480Mbps) is not supported.

The USB port is disabled by default. To enable it, remove the jumpers on headers JP4 and JP5 as shown below.

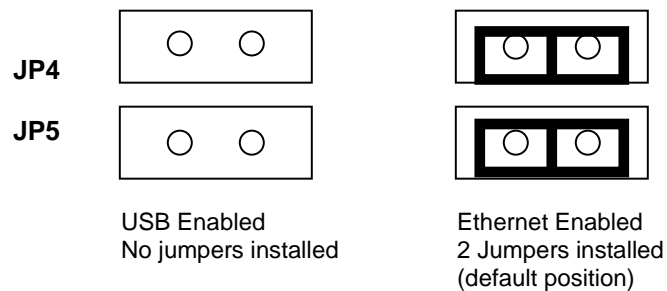

**Figure 10 USB/Ethernet Jumper Settings**

**IMPORTANT:** Do not plug a USB device into the USB port if the Ethernet port is enabled.

## Ethernet Port

The Ethernet port, located on J2, can be used for configuring and testing the SX-560. Ethernet provides an easier way to do the initial setup and configuration of the SX-560, because you do not have to worry about wireless security configuration parameters. Operation of the SX-560 through this port is identical to wireless operation, except that wireless security is not supported. Ethernet is enabled by default (see previous section for information on jumper settings).

Note that because the Ethernet port is connected through the USB host port, it cannot be used at the same time as the USB port. Also, when the Ethernet port is used, the 802.11a/b/g wireless port is disabled.

## Additional OEM Interface Signals

The output LED signals ORLED-, GRLED- and YELED- represent the state of the LEDs on the module. Logic 0 indicates the LED is on, and Logic 1 indicates the LED is off. Buffers are recommended if LEDs are to be driven on the end-user side.

The SWITCH signal is connected to a momentary pushbutton switch (Test Button) on the Evaluation Daughtercard and is in the normally open position. Depressing the switch causes a short to ground. A 4.7 K-ohm pull-up resistor to +3.3 VDC is connected. The module's processor monitors this signal. The end-user can drive or use open-collector to this signal to either logic level or can monitor this signal as an input. The Test Button is normally used either to send configuration information to a printer (button momentarily pressed) or to reset the SX-560 to its default configuration (button held down for more than 5 seconds).

## Serial Peripheral Interface

The four SPI signals are accessible using the 26-pin I/O header JP3. The SPI MOSI, SPI MISO, and SPI Clock signals are routed to both the JP3 header and an on-board temperature sensor. The temperature sensor can be disabled by removing the jumper from the TSPICS signal on JP7 as described in the GPIO Special Functions section above.

## LCD Interface

A 16x2 LCD display is available as an option for the SX-560-6900 Evaluation Daughtercard. This LCD can be controlled from either Serial Port 2 or via the SPI interface. The LCD display plugs into header JP1. Header JP12 is used to select serial or SPI control (place a jumper on pins 1 and 2 to select serial, or place the jumper on pins 2 and 3 to select SPI).

## OEM Interface Electrical Characteristics

Table 12 OEM Signal Parameter Descriptions

Parameter	Symbol	Condition	Minimum	Maximum	Unit
Input high voltage	Vih		2.0 ▼		Volts
Input low voltage	Vil			0.8	Volts
Output high voltage UART0_TXD, UART0_RTS, UART1_TXD, UART1_RTS UART2_TXD	Voh	Ioh = 4mA	2.4		Volts
Output low voltage UART0_TXD, UART0_RTS, UART1_TXD, UART1_RTS UART2_TXD	Vol	Iol = 8mA		0.4	Volts
Output high voltage GPIO 1 to 10, SPI, CS, SPI_SDO, SPI_CLK, Reset_N	Voh	Ioh = 8mA	2.4		Volts
Output low voltage GPIO 1 to 10, SPI, CS, SPI_SDO, SPI_CLK, Reset_N	Vol	Iol = 8mA		0.4	Volts
Input Leakage Current	Ii	0 < Vin < 3.3v	-10	+10	μA



# Chapter 3

## Configuring the SX-560

**IMPORTANT:** This chapter assumes that you are either using the SX-560-6900 Evaluation Daughtercard or that you have made the appropriate connections to the SX-560 module OEM Header. Refer to Chapter 2 and Chapter 5 for information on connecting to the SX-560 hardware.

This chapter describes the methods for configuring the basic settings of the SX-560, including the IP address, serial port settings, and wireless security. The SX-560 also has an extensive range of advanced configuration capabilities that are described in Chapter 6, Appendix A, and Appendix B. The SX-560 configuration should be done by a network administrator or another person with technical knowledge of TCP/IP networking and serial communications.

### Basic Configuration Requirements

In order to use the SX-560, the following basic parameters must be configured:

#### TCP/IP Settings:

- IP Address
- Subnet Mask
- Router Address

Note: The TCP/IP settings can be automatically configured using DHCP.

#### Wireless Configuration Settings:

- SSID
- Mode (Infrastructure or Ad Hoc)
- Channel (required only if using Ad Hoc mode)

#### Security Settings:

- Wireless Encryption Mode (WPA2, WPA, WPA2-WPA, WEP)
- Wireless Encryption Settings
- Wireless Authentication Mode (WPA-PSK, Open System, Shared Key, TTLS, TLS, LEAP, PEAP, EAP-FAST)
- Authentication Settings

Note: There are numerous possible encryption and authentication settings, and every network can have different settings. Please refer to Appendix A for a detailed summary of these settings.

#### Serial Port Settings (must match the settings of the attached serial device):

- Baud Rate (Speed)

- Parity
- Character Size
- Flow Control

In addition to the above parameters, the SX-560 allows you to configure numerous other capabilities. These other capabilities provide you with the unparalleled flexibility to use the SX-560 on virtually any 802.11a/b/g network with virtually any RS-232 serial device.

## Initial Wireless Setup

**NOTE:** Skip this section if you are using the Ethernet port on the SX-560-6900 Daughtercard for the configuration process, or if you are using a terminal connected to one of the serial ports on the SX-560.

If you are using a wireless network connection for the first-time configuration of the SX-560, you must set up a temporary ad hoc wireless connection as described in the following steps.

1. Disconnect your PC and the SX-560 from your network, and temporarily change the PC settings as follows:
  - IP address: 192.0.0.191
  - Wireless Mode: **Ad Hoc** (sometimes referred to as Peer-to-Peer)
  - Channel: **11**
  - SSID (or wireless network name): **serserv**
  - Make sure that all network security is disabled.
2. Power on the PC and the SX-560. You can connect to the SX-560 by specifying its default IP address of 192.0.0.192 using the ExtendView utility or a web browser as described in the next sections. After you have connected, you can use ExtendView, the internal web pages, or the internal console to change the SX-560 configuration as follows:
  - a. Enable AUTO as the boot method or IP address resolution method on the SX-560, or manually change the IP address to the one you will actually be using on your network.
  - b. Enter the required wireless networking parameters on the SX-560 for operation on your wireless network (for example, SSID, mode, and wireless security).
  - c. Change the serial port settings to match those of your device.
3. After you complete the entire SX-560 configuration process:
  - a. Set your PC back to its original network settings, and restart it.
  - b. Restart the SX-560. The new settings will take effect after the SX-560 has restarted.

## Configuration Methods

There are three ways to configure the SX-560:

- *ExtendView*. ExtendView is a simple Graphical User Interface configuration program for Windows. It has the advantage of allowing you to perform bulk configuration of multiple SX-560s simultaneously. If you are using a wired Ethernet connection with the SX-560-6900 evaluation daughtercard, ExtendView also lets you set the IP address and wireless network settings into an unconfigured SX-560 device server (if you are using a wireless network connection for connection, then you must first configure the IP address and wireless network settings using the Initial Wireless Setup procedure described previously in this chapter, or the internal command console).

- *Internal Web Pages (HTTP)*. You can use any standard web browser to access the SX-560 internal web pages. These web pages provide an easy-to-use graphical interface for configuring the SX-560. In order to use the internal web pages for the first time, you must assign the SX-560 IP address and wireless network settings using some other method (for example, the Initial Wireless Setup procedure described previously in this chapter, or the internal command console). This initial IP address assignment need only be done one time.
- *Internal Command Console*. The internal command console provides a sophisticated command line interface for advanced users to configure the SX-560. It can be accessed by connecting a serial cable to serial port 2 or serial port 3 (serial port 1 can also be used to access the internal command console by sending the AT#C command or defining a console mode string as described in Chapters 4 and 6). Once the IP address and wireless network settings have been configured, the internal command console can also be accessed via TELNET, or via ExtendView and the internal web pages.

Configuring the SX-560 using each of the above methods is described in the following sections of this chapter.

# Using the ExtendView Utility to Configure the SX-560 (Ethernet Connection)

**NOTE:** Skip this section if you do not have a Windows PC or if you prefer to use the internal web pages or internal command console for configuration.

The ExtendView Utility is the easiest way to initially configure the SX-560 from a Windows PC because it allows you to directly set the IP address into an unconfigured SX-560 if you are using the SX-560-600 evaluation daughtercard Ethernet port, and it allows you to view the IP addresses of all of the SX-560s on your network. It has limited capabilities for configuring 802.1X authentication, but it can be used in conjunction with either the internal web pages or the internal command console for complete configuration capabilities.

ExtendView is a component of the CD-ROM that is included with the Evaluation Daughtercard, or it can be downloaded from the Silex website. To install ExtendView, simply follow the on-screen installation instructions and then restart your computer when the installation procedure is complete. The SX-560 configuration procedure is as follows (please note that the screens may be slightly different than shown, depending on the SX-560 model and the firmware and software revision levels).

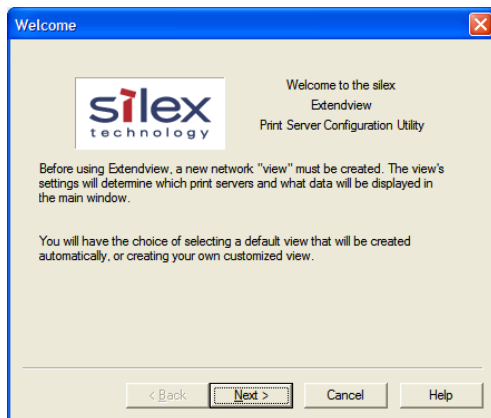

1. Start the ExtendView Utility by clicking on **Start, Programs, silex technology, ExtendView**, and then **ExtendView**.

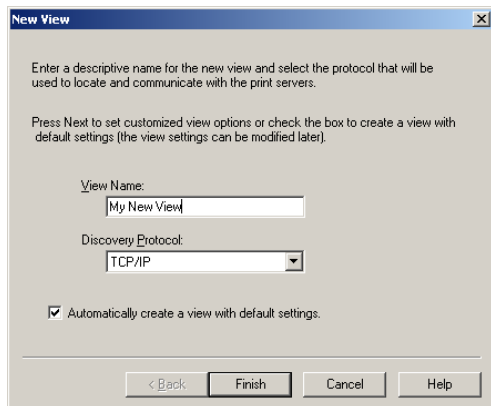

2. When the Welcome screen appears, click on **Next**, choose any name for your **View Name**, select **Automatically create a view with default settings** (or configure the view to your preferences), and then click **Finish**.

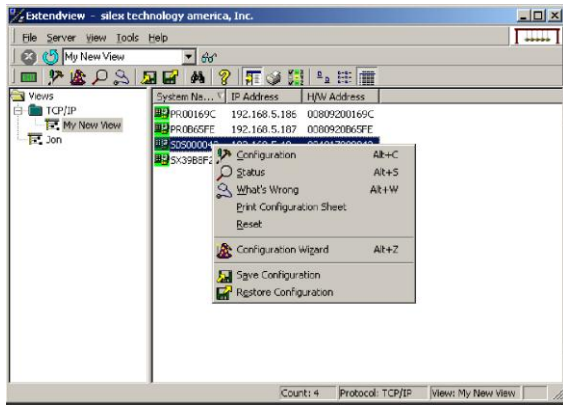

- Right-click on the SX-560 that you want to configure from the displayed list, and then left-click on **Configuration**. The default SX-560 name is SDSxxxxxx (where xxxxxx is the last six digits of the MAC address from the label that is affixed to the SX-560).

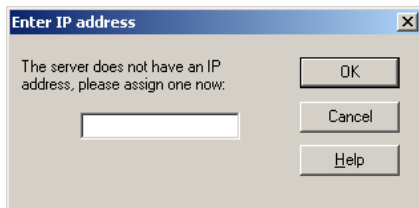

- If you do not have a DHCP server, you will be asked to manually enter an IP address (if you are not sure what IP address to enter, ask your network administrator). Click **OK** when you are finished.

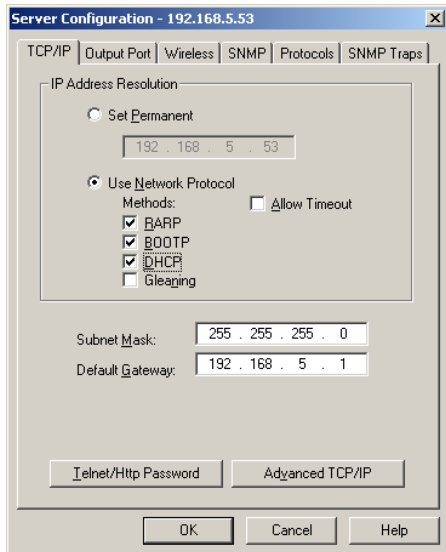

- The Server Configuration window will appear. Check the IP address setting to make sure it is correct. If necessary, change the Subnet Mask and Gateway. If you have a WINS server, enter its address or click **Use DHCP to Locate WINS Server**. If desired, you can configure advanced TCP/IP settings by clicking the **Advanced TCP/IP** button (refer to Chapter 6 for information). This advanced configuration can be done at a later time, however.

**NOTE:** If you are using DHCP on your network, the SX-560 should have acquired valid IP settings at this point and no further IP address configuration is necessary. However, for some installations, a static IP address is preferred. If your DHCP server does not allow the SX-560 to keep its assigned IP address permanently, then you must manually assign an IP address. In this case, use a static IP address outside the range reserved for DHCP (see your DHCP server documentation for details). To assign a static IP address, select **Set Permanent** as the **IP Address Resolution**, and assign a valid static IP address for your network. Click on **OK** to save the new settings.

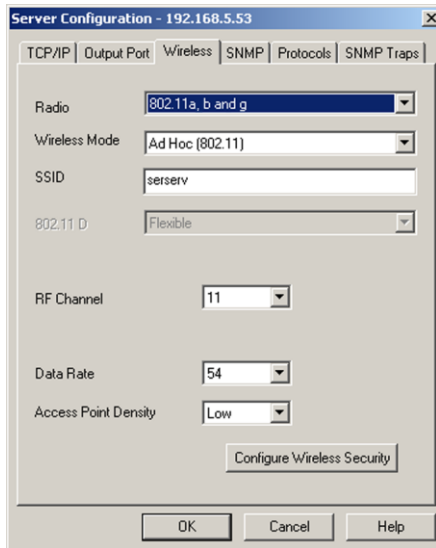

6. Click the **Wireless** tab to configure the 802.11a/b/g wireless settings. To operate on an 802.11a/b/g network, the SX-560 configuration must be configured with the wireless configuration and security parameters necessary for the SX-560 to communicate over your wireless network (check with your network administrator if you do not know these parameters).
  - Select either Infrastructure (if you are using an access point) or Ad Hoc (point-to-point) as the wireless mode
  - Enter the SSID for your network
  - If you are using Ad Hoc, select the RF channel (not required for infrastructure)

The other parameters on this tab do not normally need to be changed (refer to Chapter 6 for information on advanced configuration).

Now click the **Configure Wireless Security** button to configure the wireless security parameters.

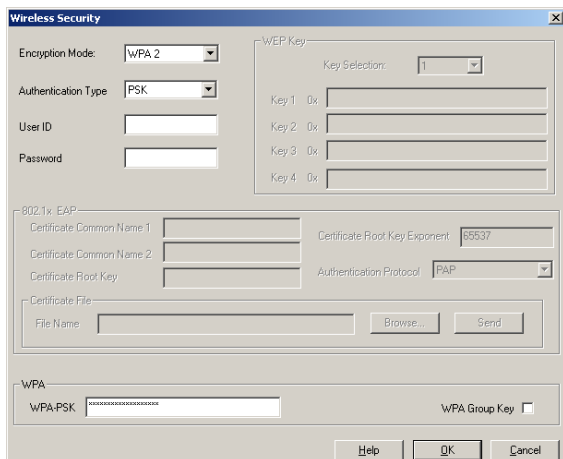

7. If you are using WPA2-PSK, select WPA2 as the Encryption Mode and select PSK as the Authentication Type. If you are using WPA-PSK, select WPA as the encryption mode and select PSK as the Authentication Type. For both WPA2-PSK and WPA-PSK you must enter the Pre-Shared Key for your network and select whether you want a Group Key. Note that it is not necessary to enter a User ID or password.

If you are using WEP, select 128-bit or 64-bit as the Encryption Mode and Open Systems or Shared Key as the Authentication Type. Enter the WEP keys in hexadecimal format, and select the transmit key (Key Selection).

ExtendView does not fully support configuration of the 802.1X EAP types, so Sillex recommends using the internal web pages or internal command console for 802.1X configuration as described later in this chapter.

Click **OK** to return to the Server Configuration window, and then click the I/O port tab to configure serial port 1.

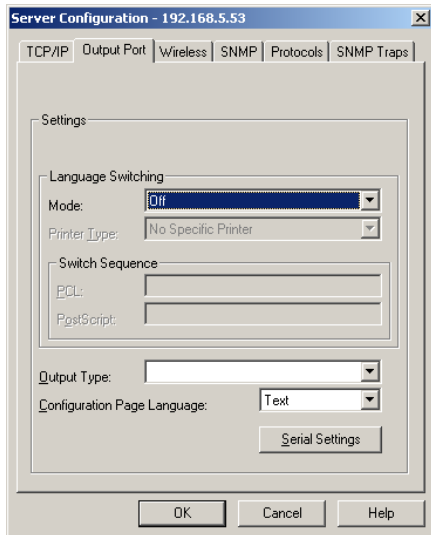

- You do not need to change any of the settings in this window. Click the **Serial Settings** button to configure the serial port.

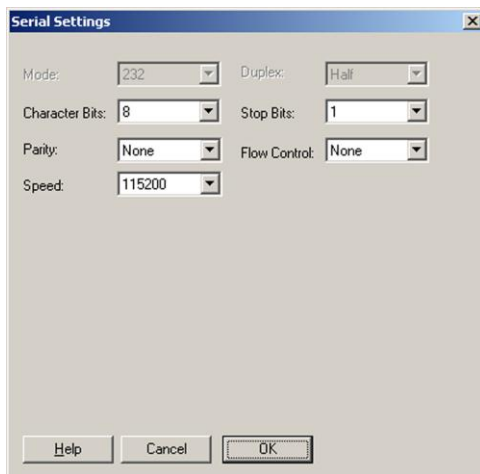

- Select the desired serial port, and configure the serial port settings so that they match the settings on your device. For example, if your device is set for 9600bps, odd parity, and XON/XOFF flow control, you must change the settings on the SX-560 to these settings

Click **OK** when you are finished to return to the Server Configuration window and then click **OK** again.

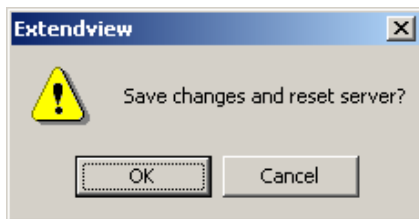

- Click **OK** to save your changes and reset the SX-560. You can now use the SX-560 on your network. You may skip the remaining sections of this chapter, although this information is useful for future reference.

# Using a Web Browser to Configure the SX-560

You may skip this section if you have completely configured the SX-560 using ExtendView. However, if you have advanced configuration requirements, such as 802.1X EAP configuration, then you may need to use the internal web pages as described in this section because ExtendView does not support these capabilities.

After you have entered an IP address into the SX-560, you can use any standard web browser to access the internal web pages for configuring the SX-560. Simply specify the IP address of the SX-560 in your browser and then follow the steps below:

**IMPORTANT:** You must click the *Submit* button when you have finished configuring an internal web page. If you do not do this, your changes will not be saved.

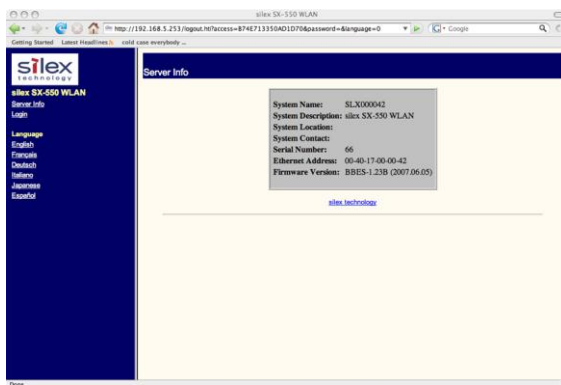

1. When you have connected to the SX-560, you will get the Server Info page. Click **Login** on the left side of the screen.

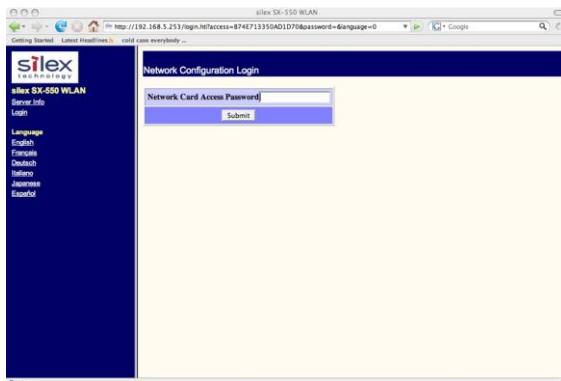

2. Enter the password **access** and press **Submit**.



3. You will return to the Server Info page, but new options will be listed on the left side of the screen. Click on **TCP/IP**.



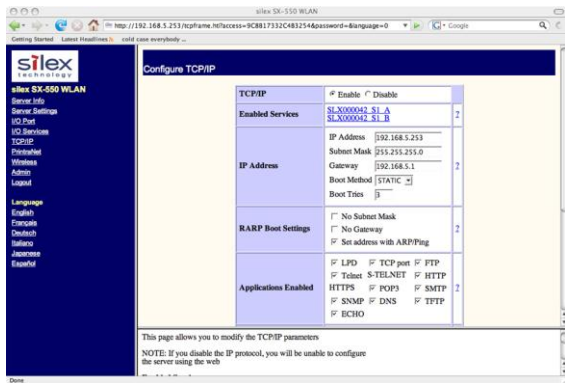

If you used DHCP, verify that the IP address is correctly set. If you used the default 192.0.0.192 IP address, you **MUST** change it to a new valid IP address. If necessary, change the Subnet Mask and Gateway. It is generally not necessary to change the other parameters on this page (refer to Chapter 6 for advanced configuration information).

Note that on-line help information is available on every configuration page.

Click the **Submit** button at the bottom of the window (you may need to scroll) to save your changes.

**NOTE:** If you are using DHCP on your network, the SX-560 should have acquired valid IP settings at this point and no further configuration is necessary. However, for some installations, a static IP address is preferred. If your DHCP server does not allow the SX-560 to keep its assigned IP address permanently, then you must manually assign an IP address. In this case, use a static IP address outside the range reserved for DHCP (see your DHCP server documentation for details). To assign a static IP address, select *Set Permanent* as the *IP Address Resolution*, and assign a valid static IP address for your network. Click on **OK** to save the new settings.

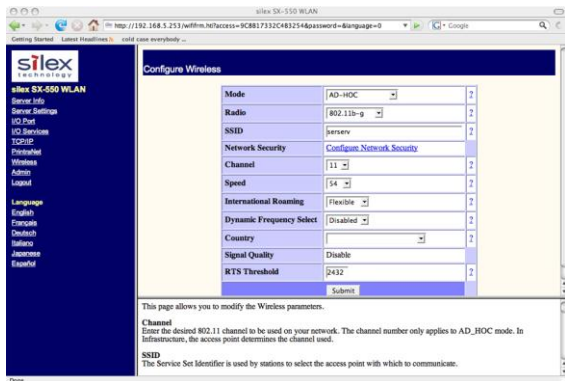

4. Click **Wireless** on the left side of the screen to configure the 802.11a/b/g wireless settings (for WLAN models only; skip to the next section if you have an Ethernet model). To operate on an 802.11a/b/g network, the SX-560 configuration must be configured with the wireless configuration and security parameters required to allow the SX-560 to communicate over your wireless network (check with your network administrator if you do not know these parameters).

- Select either Infrastructure (if you are using an access point) or Ad Hoc (point-to-point) as the wireless mode
- Enter the SSID for your network
- If you are using Ad Hoc, select the RF channel (not required for infrastructure)

The other parameters on this page do not normally need to be changed (refer to Chapter 6 for information on advanced configuration).

Click the **Submit** button at the bottom of the window (you may need to scroll) to save your changes.

Now click **Configure Network Security** to configure the wireless security parameters.

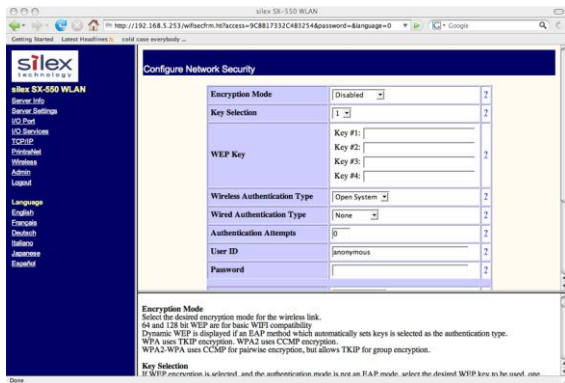

5. Select the appropriate wireless encryption mode and enter the required settings (check with your network administrator for the proper settings if you do not know them). Appendix A lists the possible encryption settings.

Click the **Submit** button at the bottom of the window (you may need to scroll) to save your changes.

Now click **I/O Port** on the left side of the screen to configure the serial ports, and then click either **S1** to configure Serial Port 1 or **S2** to configure Serial Port 2.

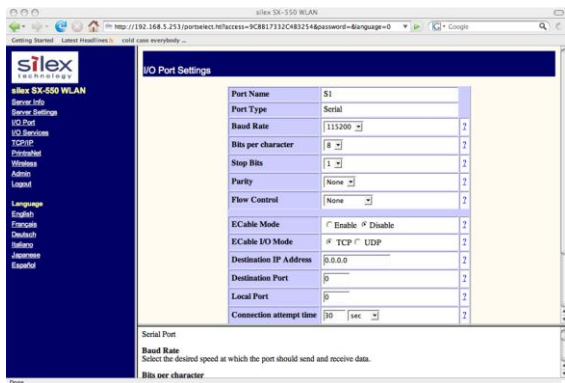

6. Configure the serial port settings so that they match the settings on your device. For example, if your device is set for 9600bps, odd parity, and XON/XOFF flow control, you must change the settings on the SX-560 to these settings.

Click the **Submit** button at the bottom of the window (you may need to scroll) to save your changes.

*When you have finished with all your configuration changes, you must restart the SX-560 for these changes to take effect.*

You can skip the remainder of this chapter.

## Using the Internal Command Console to Configure the SX-560

You may skip this section if you have completely configured the SX-560 using ExtendView or the SX-560 Internal Web Pages. However, if you are using the bridge mode, you **MUST** use the Internal Command Console (see Chapter 4 for information on configuring bridge mode).

The Internal Command Console is a command line oriented method for configuring the SX-560. It provides more comprehensive capabilities than either ExtendView or the Internal Web Pages, but is not as easy to use. Advanced users may prefer to use this method because it is concise, fast, and powerful.

To use the Internal Command Console:

1. The simplest way to access the Internal Command Console is via a terminal (for example, a Windows PC running the HyperTerminal Accessory program) connected to serial port 2 or 3. If you are using the SX-560-6900 Evaluation Daughtercard, the included serial cable can be used for this purpose. If you are not using the Evaluation Daughtercard, then you must provide the appropriate cable to connect pins 21, 22, and one of the ground pins on the OEM header to the terminal (transmit data on the SX-560 must connect to receive data on the terminal, and vice-versa). The terminal must be set for 115.2Kbps, 8-bit characters, no parity, and no flow control.
2. If you are connected to Serial Port 3, you will see some information about the firmware versions and copyright notices displayed on the terminal (skip to the next step if you are connected to

Serial Port 2). Enter *admin* when you get the *login:* prompt, and then enter the password *access*. Then enter the command *console* in response to the Linux *#* prompt.

**Note:** Early versions of the SX-560 firmware require you to login as *root* with the password *access*, and to enter command *.console* to access the console.

- When you see the *Local>* prompt, you can enter commands (note that this command may take up to 30 seconds to appear if you are using Serial Port 2). The SX-560 is set by default to use DHCP to obtain the IP address automatically. If you want to set the IP address manually, enter the following commands:

```
SET IP ADDRESS aa.bb.cc.dd
SET IP SUBNET aa.bb.cc.dd
SET IP ROUTER aa.bb.cc.dd
```

where *aa.bb.cc.dd* is the IP address of the SX-560. You can use the command *SHOW IP* to verify the IP address settings.

- Enter the basic wireless settings as follows:

```
SET NW SSID <name>           [where <name> is the SSID for your network]
SET NW MODE <mode>           [where mode is INFRASTRUCTURE or
                              AD-HOC]
SET NW CHANNEL n             [where n is 1 to 11; this is only required for
                              AD-HOC MODE]
```

- Use the appropriate *SET NW* command to set wireless encryption mode and authentication type (check with your network administrator for the proper settings if you do not know them):

```
SET NW ENC <mode>            [sets encryption mode, where <mode> is WPA,
                              WPA2, 64, 128, or WPA2-WPA]
SET NW AUTHTYPE <type>       [sets authentication type, where <type> is
                              OPEN, SHARED, TTLS, PEAP, WPA-PSK,
                              LEAP, TLS, or FAST].
```

For WPA2-PSK or WPA, enter the command:

```
SET NW WPAPSK <psk>         [sets pre-shared key for WPA2 or WPA, where
                              <psk> is the key]
SET NW WPAGROUP <state>     [enables or disables WPA group key mode,
                              where <state> is ENABLED or DISABLED;
                              default is DISABLED]
```

For WEP (WEP64 or WEP128), use the following commands:

```
SET NW KEYVAL <key>         [Sets WEP key, where <key> is 10 hex
                              characters for WEP64 or 26 hex characters for
                              WEP128]
SET NW KEY# n               [sets the number of the WEP key that will be
                              used as the transmit key, where n=1 to 4; default
                              value is 1]
```

Configuring 802.1X EAP authentication can be complex. Please refer to Appendix A and/or Appendix B for details of the required commands.

6. To set the serial ports, enter the following commands (If you are configuring Serial Port 2, substitute the port name S2 instead of S1):

SET PORT S1 SPEED <baudrate>	[where <baudrate> is 300 to 921600]
SET PORT S1 PARITY <parity>	[where <parity> is ODD, EVEN, MARK, or SPACE]
SET PORT S1 SIZE <databits>	[where <databits> is 7 or 8]
SET PORT S1 FLOW <flowcontrol>	[where <flowcontrol> is NONE, XON/XOFF, CTS, or DSR]

The console commands are summarized in Appendix B of this manual.

7. When you have finished entering commands type:

```
INIT
EXIT
```

These commands will save the configuration and restart the unit. You are now ready to use the SX-560.

**IMPORTANT:** The console command EXIT must always be used in order to save the changes you made with the internal command Console.

8. After an IP address and wireless network settings are configured in the SX-560, you can also access the Internal Command Console in any of the following ways:

- **TELNET.** From the Windows Command Prompt (MS-DOS Prompt), Mac OS X Terminal Utility, or UNIX/Linux command line, enter the command:

```
telnet aa.bb.cc.dd
```

where *aa.bb.cc.dd* is the IP address of the SX-560. Enter *admin* when you get the *login:* prompt, and then enter the password *access*. Then enter the command *console* in response to the Linux # prompt. When you get the *Local>* prompt, you are ready to enter console commands.

- **Internal Web Pages.** Use a web browser to connect to the SX-560 internal web pages as described earlier in this chapter. After you have logged in, click **Admin** on the left side of the screen, and then click **Console**. You can now enter console commands (you must click **Enter** after each command).
- **ExtendView.** Select the desired SX-560 from the ExtendView main menu. Click **Tools** on the menu bar, and then click **Telnet Session**. Enter *admin* when you get the *login:* prompt, and then enter the password *access*. Then enter the command *console* in response to the Linux # prompt. When you get the *Local>* prompt, you are ready to enter console commands.

# Chapter 4

## Using the SX-560 with Your Application

The SX-560 includes a number of capabilities that enable it to be used in a wide range of applications. These capabilities include:

1. Linux programmability
2. User interface customization
3. Power configuration
4. Serial Port Emulator (SPE) software
5. Raw TCP connection
6. RFC2217
7. ECable Mode
8. Print Server mode
9. Console mode switching
10. AT commands
11. SNMP traps

These capabilities are described in the following sections.

### Linux Programmability

The SX-560 runs a full implementation of the Linux operating system, so it can be programmed for a variety of applications using standard Linux tools. To access the Linux operating system, connect to the SX-560 either directly through Serial Port 3 or by using TELNET over the network. Enter the user name *admin* in response to the *login:* prompt, and then enter the password *access* to get the Linux *#* prompt.

If you need root privileges, you can use the Linux *su* utility with the default password *access*. Both the admin password and the root password can be changed via the Linux shell *passwd* command.

**IMPORTANT:** Root privileges provide total access to the Linux operating system. Because of the possibility of modifying or deleting critical SX-560 system files, only knowledgeable Linux programmers should use this capability.

### Customizing the SX-560 User Interface

The SX-560 user interface can be customized to include your company's name or other information. For example, instead of displaying **Silex SX-560** on the internal web pages and the internal command console interface, the SX-560 could display **Company XYZ**. In addition, the 3-character OEM code used in the SX-560 server name and service names can be changed from the default code **SDS** to a user-defined code. For example, by changing the OEM code to XYZ, the default server name **SDS000345** would become **XYZ000345**. To make these changes, enter the following commands using the internal command console:

SET OEM <i>code</i>	where <i>code</i> is the desired 3-character OEM code
SET DEFAULT	[note that this resets the entire SX-560 configuration back to the factory defaults]
SET SERVER DESC <i>description</i>	where <i>description</i> is any string up to 32 characters in length [note that spaces are OK in the description and no quotation marks are necessary]
INIT	[restarts the SX-560 when the user exits the console]
EXIT	[exits the console]

**IMPORTANT:** This user interface customization must be done *before* making any other configuration changes, because the SET OEM command requires that the SX-560 be reset to the factory default configuration.

## Power Configuration

The SX-560 can be set to go into power save mode by using the console command

SET POWER *n*

where *n* is 0 for high (power is always on; this is the default setting) and 1 for low (lowest power consumption). The SHOW POWER command shows the current power configuration.

When power save mode is on, the radio will go to sleep when no activity is detected after a period of time that is determined by a preset algorithm in the SX-560. The radio will wake up in less than a second if there is data waiting for it on the access point, and it will wake up immediately if the SX-560 has a data packet ready to transmit.

## Serial Port Emulator

The Serial Port Emulator (SPE) software emulates a standard Windows COM port. That is, it creates a virtual COM port that functions exactly like the Windows COM1 and COM2 serial ports, except that the I/O actually goes out over the Ethernet or WLAN to the SX-560 and to the serial device that is connected to the SX-560. As a result, any application program that uses a standard Windows COM port can also use the Serial Port Emulator. The SPE is therefore especially useful if you have existing programs that use Windows COM ports.

The SPE software can be downloaded from the Silex website. To install it, follow the on-screen instructions and then restart your computer when the installation is complete. You can now run the SPE software by clicking **Start -> Programs -> silex technology -> Serial Port Emulator -> Serial Port Emulator**.

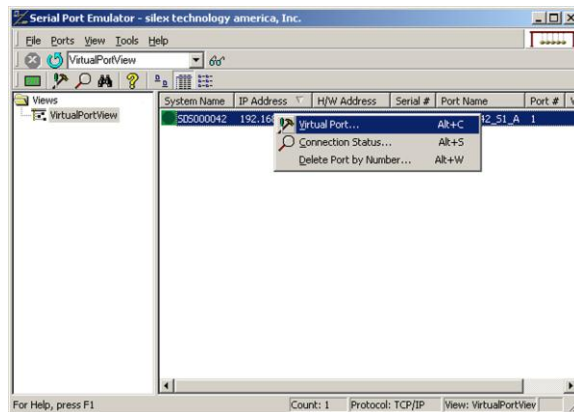

After the Serial Port Emulator software has started, you will see a list of all the configured SX-560s on the network. Right click on the name of the SX-560 that you want the virtual COM port to connect to (the default name is SDSxxxxxx, where xxxxxx is the last six digits of the SX-560 MAC address), and then click **Virtual Port**. You will be asked to select the name of the virtual COM port (for example, COM3).

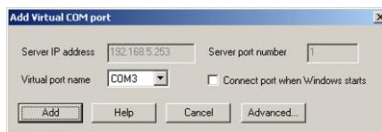

Click **OK** after you have selected the name, and you now ready to use the virtual COM port.

Using virtual COM port is identical to using a normal COM port. For example, if you configure a virtual COM port called COM3, this port will show up as one of the available serial ports when you use the Windows HyperTerminal Accessory program.

## Raw TCP connection

You can communicate directly from your application program to the SX-560 using a raw TCP connection. This is done by opening a TCP port on the SX-560 and then sending and receiving data to this port via a socket or equivalent API. This method is more efficient than using the Serial Port Emulator, and does not require any additional software to be installed on your computer.

If you are using a raw TCP connection, the default TCP port number is either 9100 or 3001 for Serial Port 1 or 9101 or 3002 for Serial Port 2 (you can use any or all of these port numbers) for normal connections. If you want to be able to access your device's modem control signals from your computer system, then the TCP port number is 9200 for Serial Port 1 or 9201 for Serial Port 2 (this enables RFC 2217 support). You can change the port number, if desired, by modifying one of the SX-560 services. To change the TCP port number:

1. Connect to the SX-560 with a web browser (see chapter 3 for instructions on doing this);
2. After you have logged in, click **I/O Services** on the left side of the page.
3. Click on the service name that you want to change (any one of the services is OK, provided that you are not using the existing TCP port number of that service for a different application).
4. Change the **Raw TCP Port** to the desired number (must be greater than 1023).
5. Click **Submit** to save your change.

You can test this connection by using the TELNET utility from the Windows Command Prompt (MS-DOS prompt), Mac OS X Terminal Utility, or UNIX/Linux command line as follows:

```
telnet ipaddress portnumber
```

where *ipaddress* is the IP address of the SX-560 and *portnumber* is the SX-560 TCP port number. For example:

```
telnet 192.168.5.53 9100
```

In this example, if you have a serial printer or other device capable of displaying ASCII characters connected to the SX-560 Serial Port 1, then every character you type should be printed on that serial device (buffered serial devices may need you to type a control character such as a formfeed (CONTROL-L) before the characters are printed).

## RFC 2217 Remote Modem Control Support

RFC 2217 allows you to access your device's modem control signals over the network. It is especially useful for migrating applications that use modem controls from a direct serial connection to a serial device server network connection. You can utilize RFC 2217 from the Silex Serial Port Emulator software (see below), or by connecting to TCP port 9200 (for Serial Port 1) or port 9201 (for Serial Port 2) from your application program.

## ECable Mode

Normally, it is up to the computer to initiate a connection to the SX-560. For some applications, it is desirable for the SX-560 to initiate the connection to the computer. The SX-560 supports this capability through its ECable feature.

To set E-Cable mode, use a web browser to access the SX-560 internal web pages (see chapter 3 for instructions on using the internal web pages). After you have logged in, click I/O port on the left side of the screen.

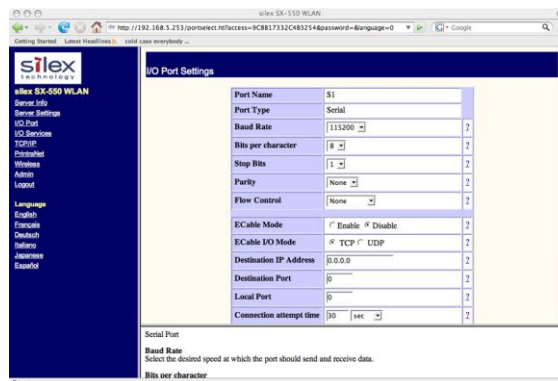

You can now enable ECable mode and set the required parameters.

1. Select the desired port (S1 for Serial Port 1 or S2 for Serial Port 2)
2. Enable ECable mode by clicking the radio button.
3. Enter the address (Destination Address) of the computer or other device that will be communicating with the SX-500)
4. Enter the TCP port number (Destination Port) used by the destination device for communicating with the SX-560 (must be greater 1023).
5. If desired, change the ECable Connection Attempt Time. This specifies the time interval between connection attempts. For example, by default the SX-560 will try once every 30 seconds to make a connection to the destination device; if it fails to make this connection, it will wait 30 seconds before attempting again. Changing this interval will reduce or increase the amount of network traffic.
6. It is also possible to use UDP instead of TCP for communicating to and from the SX-560. If you wish to use UDP, then:
  - a. Select UDP as ECable I/O Mode.
  - b. Enter the UDP port number (Destination Port) used by the destination device to communicate with the SX-560. This number must be a valid port on the destination device (check the documentation for that device to determine the valid port numbers).
  - c. Enter the UDP port number (Local Port) used by the SX-560 to communicate with the destination device. This number must be greater than 1023, but is otherwise arbitrary.

**NOTE: ECable mode cannot be used in conjunction with the Serial Port Emulator software.**



## Print Server Mode

You can use the SX-560 as a standard TCP/IP print server, which is very useful if you are connecting the SX-560 to a serial printer. The SX-560 supports the following standards:

- *lpr/lpd*. This is one of the most popular ways to print on a TCP/IP network. Check your computer's documentation to determine how to set up an lpr print queue. Usually this simply involves specifying the IP address of the SX-560 as the printer's address or host name. Some implementations require a queue name; this name is the name of any of the SX-560 services. To see the names of the SX-560 services, connect to the SX-560 with a web browser (see chapter 3 for instructions on doing this); after you have logged in, click I/O Services on the left side of the page. Note that if you are printing to Serial Port 2 (S2), you *must* specify an S2 service (for example, SDS057333\_S2\_A) as the queue name.
- *Port 9100*. This method is used to set up a Windows Standard TCP/IP port or for compatibility with software that supports the HP JetDirect Print Server (for example, HP Web JetAdmin). To use this capability on Windows with the *Add Printer Wizard*, specify that you want to use a **Local printer attached to this computer** (not a network printer), and then select **Create a new port**, specifying **Standard TCP/IP Port** as the type of port.

Note that if you are printing to Serial Port 2 (S2) instead of Serial Port 1 (S1), the TCP port number is 9101. It is also possible to change the TCP port number from the default 9100 for compatibility with other printer manufacturer's software. To do this, refer to the instructions in the *Raw TCP Connection* section of this chapter.

## Console Mode Switching

The SX-560 allows you to dynamically switch the operation of Serial Port 1 or Serial Port 2 from normal mode to console mode. This allows your device to control the operation of the SX-560 by sending console commands (see chapter 6 and Appendix B for a description of the console commands).

To switch the serial port to console mode, you must first define a console mode string. When the SX-560 receives this string on the serial port, it will automatically switch the port to console mode. To define the console mode string, use a web browser to access the SX-560 internal web pages. After you log in, **click I/O Port**, and then select the desired port (S1 for Serial Port 1 or S2 for Serial Port 2). When you get the **I/O Port Settings** page, enter any desired character string (for example, ++++) as the **Console Mode String**. Click **Submit** to save your string, and then restart the SX-560 to make the change take effect.

Alternatively, you can define the console mode string using the console command as shown in the following example:

```
SET PORT S1 CONSTR ++++
```

Once you are connected in console mode, you can send any of the console commands listed in Chapter 6. Be sure to terminate each console command with a carriage return (ASCII 13) or linefeed (ASCII 10) character.

When you are finished using the console, you can return to the normal port operation by sending the command EXIT followed by a return or linefeed character.

## AT Commands

The SX-560 allows you to control Serial Port 1 and/or Serial Port 2 using standard AT modem commands. This allows you, for instance, to initiate connections and to switch between console mode

and data mode by sending the appropriate commands. This capability is similar to the console mode switching described in the previous section, but has the following advantages;

- Your device can initiate a network connection
- Operation is compatible with software that uses the AT command set

The drawback, however, is that there is a slight delay when switching from data mode to AT command mode.

To use the AT commands, you must first enable this capability using the **I/O Port Settings** internal web page for the desired port (S1 for Serial Port 1 and S2 for Serial Port 2). Change the **Port Filter** setting to AT in order to enable AT mode on that port and press the **Submit** button to save the change. You must restart the SX-560 to make the change take effect.

You can also use the console to enable the AT capabilities. For example, the command

```
SET PORT S1 FILTER AT
```

enables AT capabilities on Serial Port 1.

**NOTE: If you use the AT commands on one of the ports, you cannot use SNMP traps for that port (you can use the SNMP traps on a different port and on the GPIOs).**

The AT commands are described in detail in Chapter 6.

## SNMP Traps and GPIO Status

The SX-560 allows the user to define various alert conditions based on the state of the GPIOs or on data received by the serial port. For example, you could cause an alert to occur if the signal on GPIO 3 goes low, or if a certain user-defined string of characters is received on the serial port. When an alert occurs, it can be sent as an SNMP trap.

The SX-560 also allows the user to set the GPIOs or read the state of the GPIO pins via console commands (console commands can issued through the Serial Port 3 console port, via the console mode switch feature described earlier in this chapter, via the AT#C command described in Chapter 6, or through TELNET). In addition, you can use the SX-560 E-GPIO capability to send the state of the GPIO pins to a remote computer through TCP/IP messages at a user-defined time interval.

Details on using these capabilities can be found in Chapter 6.

## Chapter 5

# Interfacing the SX-560 to the OEM Device

In order to connect the SX-560 module to your device, you will need to provide either a custom daughtercard or a special cable. Both of these solutions will require a 40-pin female connector on one side, with the appropriate connector(s) for connecting to your device's circuitry on the other side. The custom daughtercard is generally a superior solution because it provides better mechanical connections for greater overall system reliability.

A good model for a custom daughtercard is the Silex SX-560-6900 Evaluation Daughtercard (see chapter 2 for a discussion of the Evaluation Daughtercard). To assist you in the design of your daughtercard, we have therefore included the schematics of the Evaluation Daughtercard in figure 22.

The major design considerations for the SX-560 are as follows:

- *40-pin OEM Header.* This is the primary mechanism for communications between the OEM device and the SX-560. This section describes the pinout and the mechanical considerations.
- *Antenna Connectors.* The two U.FL connectors can be used to connect a variety of antennas.
- *General Purpose I/O (GPIO).* The GPIOs can be used to control LEDs and for a variety of other purposes.
- *Power.* The power requirements for the SX-560 are stated in this chapter.

Each of these design considerations is covered in the following sections of this chapter.



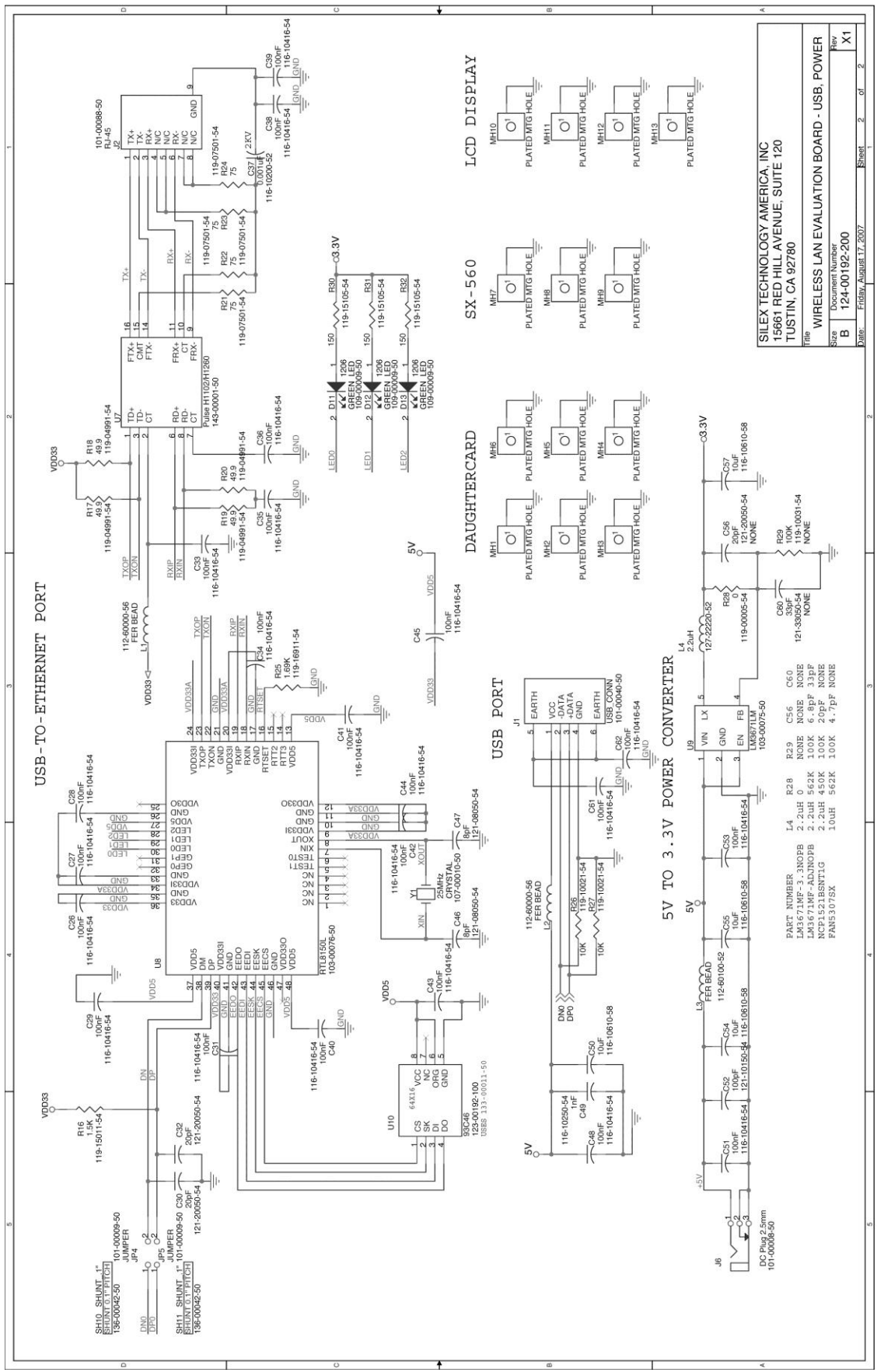

SILEX TECHNOLOGY AMERICA, INC  
 15661 RED HILL AVENUE, SUITE 120  
 TUSTIN, CA 92780

WIRELESS LAN EVALUATION BOARD - USB, POWER

Document Number  
 B 124-00192-200

Rev  
 X1

DATE: Friday, August 17, 2007 Sheet 2 of 2

Figure 8a SX-560 Evaluation Daughtercard Schematics

## OEM Interface

The OEM Interface (JP2) is the primary method for communications between the SX-560 and your device. It is a 40-pin header that includes the necessary pins for serial data I/O, GPIO, and power.

Table 13 describes the OEM interface pinout for the SX-560 module.

**Table 13 OEM Interface Pinout**

PIN	SIGNAL	PIN	SIGNAL
1	RESET-	2	GPIO_0
3	GPIO_1	4	GPIO_2
5	GROUND	6	+3.3VDC
7	GPIO_3	8	GPIO_4
9	GPIO_5	10	GPIO_6
11	GPIO_7	12	GPIO_8
13	GPIO_9	14	TXD0
15	GPIO_10	16	CTS0-
17	GROUND	18	+3.3VDC
19	USB+	20	RTS0-
21	USB-	22	RXD0
23	+3.3VDC	24	GROUND
25	SPI_CS-	26	TXD1
27	SPI_CLK	28	CTS1-
29	GROUND	30	+3.3VDC
31	SPI_MOSI	32	RTS1-
33	SPI_MISO	34	RXD1
35	+3.3VDC	36	GROUND
37	IIC_SDC	38	TXD2
39	IIC_SDA	40	RXD2

Table 13 shows the OEM interface signal descriptions. All input and output signals, except the differential signals, are 0 to 3.3V logic signals.

**Table 14 OEM Interface Signal Descriptions**

Signal	Pin	Type	Description
RESET-	1	Input/Output	Power-on Reset (low-true) Open-Drain with Pull-up
GPIO_0, GPIO_1, GPIO_2, GPIO_3, GPIO_4, GPIO_5, GPIO_6, GPIO_7, GPIO_8, GPIO_9, GPIO_10	2, 3, 4, 7, 8, 9, 10, 11, 12, 13, 15	Input/Output	General Purpose Input/Output Signals 1-10, User defined
TXD0	14	Output	Serial Port 1 Transmit Data
RTS0-	20	Output	Serial Port 1 Request to Send
CTS0-	16	Input	Serial Port 1 Clear to Send
RXD0	22	Input	Serial Port 1 Receive Data
TXD1	26	Output	Serial Port 2 Transmit Data
RTS1-	32	Output	Serial Port 2 Request To Send

Signal	Pin	Type	Description
CTS1-	28	Input	Serial Port 2 Clear to Send
RXD1	34	Input	Serial Port 2 Receive Data
TXD2	38	Output	Console Port Transmit Data
RXD2	40	Input	Console Port Receive Data
USB+	19	Input/Output	USB Data + (SEE NOTE)
USB -	21	Input/Output	USB Data – (SEE NOTE)
SPI_CS-	25	Input	Serial Peripheral Interface Chip Select (low-true) Slave Mode
SPI_MOSI	31	Output	Serial Peripheral Interface Data Out
SPI_MISO	33	Input	Serial Peripheral Interface Data In
SPI_CLK	27	Output	Serial Peripheral Interface Clock
IIC_SDC	37	Input/Output	IIC (I2C) clock
IIC_SDA	39	Input/Output	IIC (I2C) data
+3.3VDC	6, 18, 23, 30, 35	Power	Power VCC Input
GND	5, 17, 24, 29, 36	Power	Power Ground

**IMPORTANT:** If your device does not use the USB port, the USB+ and USB- signals on the OEM interfaced should be terminated with a 15K pull-down resistor to prevent errors on startup.

The SX-560 module uses the 40-pin receptacle with metal fitting and boss made by Hirose (part number DF12-40DS-0.5V81). This receptacle will work with the following mating female headers:

Hirose part number: DF12(x.x)-40DP-0.5V81

Where “x.x” is 3.5, 4.0, or 5.0 (the stacking height of the header); for example, DF12(3.5)-40DP-0.5V81. For additional information, go to the Hirose website at [www.hirose-connectors.com](http://www.hirose-connectors.com).

## SX-560 Power Requirements

The SX-560 power consumption is typically 280mA for wireless-to-serial usage, with a peak consumption is 400mA @ 3.3V. In powersave mode (refer to Chapter 4 for more information) with the SX-560 connected wirelessly to an access point, the consumption is 60mA while idling and an average of about 73mA including wakenings to answer the beacon poll.

The above numbers assume that the only active connections are the 802.11 wireless interface and the serial interface (for example, there are no connections to the GPIOs). The power supply that you select must have adequate capacity to handle the peak power plus any loads with an adequate safety margin. Power consumption specifications are subject to change; contact Silex for more information.

## Installing the SX-560

**IMPORTANT:** In order to prevent flexing of the SX-560 boards during the installation process, you must use spacers. Because of the wide range of possible OEM daughtercard connectors and other design issues, you must provide the three spacers that go between the SX-560 base module board and your daughtercard.

The spacers are installed with the SX-560-1701 WLAN model as shown below:

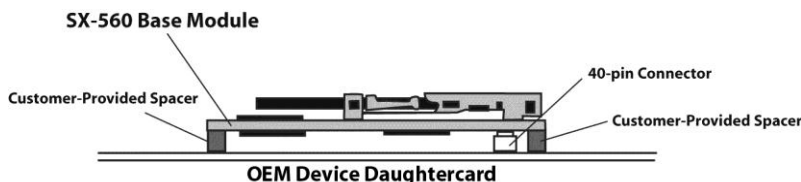

**Figure 11 Using spacers with SX-560 WLAN model**

*Do not over-tighten the screws during the installation procedure. Although the spacers provide protection against flexing, they can compress or break if too much torque is applied.*

**IMPORTANT:** Sillex does not recommend soldering the SX-560 directly to your device's daughterboard. Soldering the SX-560 will violate the standard warranty. If you must solder the SX-560, please contact Sillex Technical Support at 866-765-8761 (U.S. toll-free) or +1-801-748-1199, or e-mail us at [support@sillexamerica.com](mailto:support@sillexamerica.com)

## Antenna Connectors

The SX-560 Module has two SMT Ultra-miniature coaxial connectors (U.FL/I-PEX). describes the connector types.

For single antenna use, connect to the main antenna connector, as shown in Figure 25.

For diversity antenna use, connect to both the main and auxiliary connectors.

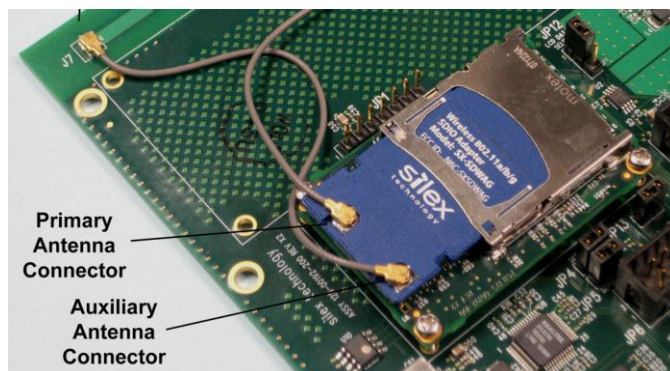

**Figure 12 Main and Auxiliary Antenna Connectors**



**Table 15 Antenna Connector Types**

Parameter	Description
Connector Type	SMT Ultra-miniature Coaxial Connector (U.FL)
Connector Size	Maximum height of 2.4 to 2.5 mm
Nominal Characteristic Impedance	50 Ohm
Rated Voltage	60 V AC (rms)
Rated Frequency	DC to 6 GHz
Contact Resistance	Center: 20 mOhm maximum Outside: 10 mOhm maximum
Insulation Resistance	500 mOhm @ 100 VDC minimum
Antenna Cable Plug	I-PEX 90 degrees plug with right angle receptacle and cable diameter at 1.32 mm

For the antenna connector, the SX-560 module uses a Hirose U.FL-R-SMT (CL331-0471-0-01) ultra miniature coaxial receptacle. Note that you must use a special cable to meet FCC regulatory requirements (see next section).

The mating plugs are:

Hirose part number: U.FL-LP-066

[www.hirose-connectors.com](http://www.hirose-connectors.com)

## SX-560-1701 Retaining Bracket (Optional)

For some SX-560-1701 applications, it is desirable to secure the radio card so that it does not accidentally eject from the SDIO card cage. Silex offers the 150-00192-100 retaining bracket as an optional accessory for these applications. This clip, which also reduces electromagnetic interference (EMI), is installed as shown in the picture below.



**Figure 13 Retaining Bracket**

## Regulatory Approval Requirements (SX-560-1701)

The SX-SDWAG used in the SX-560-1701 has FCC and IC Modular Approval. This allows you to use the SX-560 in your device without any further agency testing for intentional radiation compliance (FCC Part 15 Subparts C & E and IC RSS-210). This Limited Modular Approval has the following requirements:

- You must put the SX-SDWAG FCC or IC number in a visible location on your product. These numbers are as follows:

FCCID: N6C-SXSDWAG

IC: 4908B-SXSDWAG

- You must use either a Silex-supplied SX-SDWAG antenna (part number 108-00016-050) or a pole antenna similar to the one shown in Appendix C. If you use a non-Silex antenna, it must have a gain that is less than or equal to 2.1dBi @5.825GHz or 1.5dBi @2.4GHz. If you do not use a pole antenna, the Limited Modular Approval no longer applies and you must recertify your product for compliance with intentional radiation regulatory requirements.
- You must use a special antenna cable that has ferrite beads built-in. This cable is available as an option from Silex (part number 131-00033-050). Alternatively, you can use a cable that meets the specifications shown in Appendix C.
- In order to meet unintentional radiation standards (for example, FCC Part 15 Subpart B), Silex recommends a metal bracket similar to the one described in the previous section. This bracket provides additional grounding for the antenna connectors to reduce EMI.
- There must be at least 20cm between the SX-560 antenna and the human body to avoid the possibility of exceeding the FCC radio frequency exposure limits. If your device requires smaller distances, then you must test your device as a system with the SX-560 for compliance with specific absorption rate (SAR) requirements.
- The antenna must not be co-located or operating in conjunction with any other antenna or transmitter. OEM integrators and end-users must be provided with transmitter operating conditions for satisfying RF exposure compliance.
- The SX-560-1701 must be installed by an OEM or OEM integrator and end-users may not be provided with the module installation instructions.
- Operation in the 5.15-5.25 GHz band is restricted to indoor use only.

**IMPORTANT:** Modular Approval only covers intentional radiation requirements. Although the SX-560 is designed to comply with FCC Part 15 Subpart B Class B unintentional radiation requirements, it is your responsibility to ensure that your device complies with unintentional radiation requirements when the SX-560 is installed.

## Regulatory Approval Requirements (SX-560-2701)

The SX-SDCAG used in the SX-560-2701 has FCC and IC Limited Modular Approval. This allows you to use the SX-560 with the SX-SDCAG in your device without any further agency testing for intentional radiation compliance (FCC Part 15 Subparts C & E and IC RSS-210). This Limited Modular Approval has the following requirements:

- You must put the SX-SDCAG FCC or IC number in a visible location on your product. These numbers are as follows:

FCCID: N6C-SXSDCAG

IC: 4908B-SXSDCAG

- You must use an antenna shown in Appendix D. If you use a similar type antenna, it must have a gain that is less than or equal to the gain of these antennas. If you do not satisfy this criteria, the Limited Modular Approval no longer applies and you must recertify your product for compliance with intentional radiation regulatory requirements.
- In order to help meet unintentional radiation standards (for example, FCC Part 15 Subpart B), Silex recommends a ferrite on the antenna cable. You must evaluate your system with the SX-560-2701 installed to determine if this is required.
- There must be at least 20cm between the SX-560 antenna and the human body to avoid the possibility of exceeding the FCC radio frequency exposure limits. If your device requires smaller distances, then you must test your device as a system with the SX-560 for compliance with Specific Absorption Rate (SAR) requirements.
- The antenna must not be co-located or operating in conjunction with any other antenna or transmitter within a host device, except in accordance with FCC multi-transmitter product procedures. OEM integrators and end-users must be provided with transmitter operating conditions for satisfying RF exposure compliance.
- Device is approved for use in products operating under mobile RF Exposure conditions with respect to 2.1091. Separate approval is required for all other operating configurations, including portable configurations with respect to 2.1093 and antenna configurations other than those listed in this manual.
- Installation is limited to OEM integrators under the condition that the OEM integrator provides regulated DC power to the modules.
- OEM integrators are instructed to ensure that the end-user has no manual instructions to remove or install the device.
- Operation in the 5.15-5.25 GHz band is restricted to indoor use only.

**IMPORTANT:** Modular Approval only covers intentional radiation requirements. Although the SX-560 is designed to comply with FCC Part 15 Subpart B Class B unintentional radiation requirements, it is your responsibility to ensure that your device complies with unintentional radiation requirements when the SX-560 is installed.

## General Purpose I/O Interface

details the GPIO interface.

**Table 16 GPIO Interface**

Pin	GPIO	I/O	Drive High/Low	Description
3	GPIO_1	I/O	6/6mA	Can be set as input or output
4	GPIO_2	I/O	6/6mA	Can be set as input or output
7	GPIO_3	O or I/O	6/6mA	TSPICS SPI therma
8	GPIO_4	O or I/O	6/6mA	DTR for Serial Port 1 or used as GPIO
9	GPIO_5	I or I/O	6/6mA	DSR for Serial Port 1 or used as GPIO
10	GPIO_6	I or I/O	6/6mA	DCD for Serial Port 1 or used as GPIO
11	GPIO_7	O or I/O	6/6mA	LED 1 or used as GPIO (1=OFF, 0=illuminated)
12	GPIO_8	O or I/O	6/6mA	LED 2 or used as GPIO (1=OFF, 0=illuminated)
13	GPIO_9	O	6/6mA	Dedicated for power LED (1=OFF, 0=illuminated)
15	GPIO_10	I	6/6mA	Dedicated for Test Button (1=OFF, 0=switch depressed)

The special function capability of each GPIO can be enabled using the SET GPIO SPEC or SET GPIO SPECM command as detailed in the Advanced Configuration chapter of this manual.

## Chapter 6 Advanced Configuration

The SX-560 module is equipped with a default configuration that works with most serial-to-Ethernet connections. You can modify the settings to suit your installation requirements.

The web browser interface is the recommended method for setting advanced configuration parameters (some of the advanced configuration parameters are not accessible via ExtendView). However, regardless of the method to access the configuration parameters, the method for modifying the parameters is virtually identical.

### Factory Default Settings

**Error! Reference source not found.** displays the configuration parameter descriptions and settings with the default settings indicated in a separate column.

**Table 17 Factory Default Settings**

Parameter	Description	Settings	Default Setting
Character	Bits per character	7, 8	8
Flow	Flow control	None, Xon, Xoff, CTS/RTS	None
Parity	Parity	None, Even, Odd, Mark, Space	None
Speed	Baud rate of bits per second	300, 600, 1200, 2400, 3600, 4800, 7200, 9600, 14400, 19200, 38400, 57600, 76800, 115200, 230400, 460800, 921600	115200
Stop	Stop bits per character	1, 2	1
Mode	Line mode or serial port protocol	232, Disabled	232
Ecable	ECable mode for TCP connections	Enable, Disable	Disable
Ecaddr	ECable destination IP address	Set by user	N/A
Econn	ECable connection attempt time	1-255 seconds	30 seconds
Ecport	ECable destination TCP port number	Set by user	N/A

Parameter	Description	Settings	Default Setting
Eclport	ECable destination local IP port number (required for E-Cable UDP mode only)	Set by user	N/A
Ectmmsec	Cable connection time resolution	Enable, Disable	Disable
Ecudp	ECable UDP mode	Enable, Disable	Disable

## Restoring Factory Default Settings

The factory default settings can be restored at any time. If you are using the SX-560 Evaluation Daughtercard, hold down the test button for more than five seconds. If you are not using the evaluation board, short GPIO7 on the OEM header to ground (4.7 K-ohm pull-up resistor connected to +3.3VDC) for more than five seconds.

## Modifying TCP/IP Settings

You can modify the TCP/IP settings using ExtendView, the web browser interface or the SX-560 module's internal configuration console.

To modify TCP/IP settings:

1. Using ExtendView, click the **TCP/IP** tab. The TCP/IP window displays.

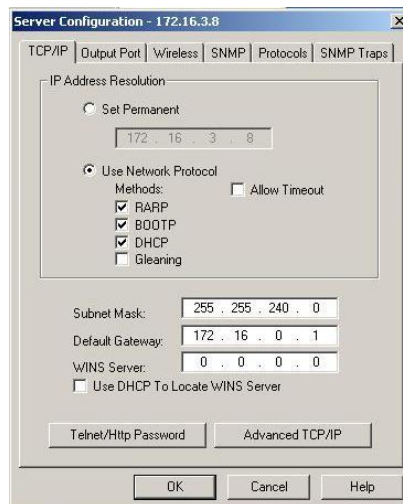

Figure 14 TCP/IP Window

2. Verify the settings, as defined in .

**Table 18 TCP/IP Settings**

Parameter	Setting
IP Address Resolution	<p>Sets the exchanges among network interfaces connected to an Ethernet media segment and maps IP address to Ethernet addresses, Media Access Control (MAC) addresses and hardware addresses.</p> <p>The <b>Set Permanent</b> radio button sets the IP address permanent. The IP address must follow the format XXX.XXX.XXX.XXX, where each XXX is a number between 0 and 255.</p> <p>The Use Network Protocol Select radio button determines which IP address at power up.</p>
Subnet Mask	<p>Sets the address of the subnet mask</p> <p>The subnet mask must follow the format XXX.XXX.XXX.XXX, where each XXX is a number between 0 and 255. The default subnet mask is 0.0.0.0. The server interprets a subnet mask of 0.0.0.0 or 255.255.255.255 as no subnet mask specified.</p>
Default Gateway	<p>Sets the default gateway, if your network is attached to other networks</p>
WINS Server	<p>Sets the Windows Internet Naming Service (WINS) address</p> <p>Values are set by user.</p>
Use DHCP to Locate WINS Server	<p>Uses the automatic location feature in ExtendView to locate the WINS servers.</p>

3. To change the Telnet/HTTP password, click Telnet/HTTP Password. The Change Password window displays.



**Figure 15 Change Password Window**

Type the new password in the **New Password** field, then in the **Verify Password** field. Click **OK** to change the password or click **Cancel** to exit.

4. Click **Advanced TCP/IP**. The Advanced TCP/IP Configuration window displays.

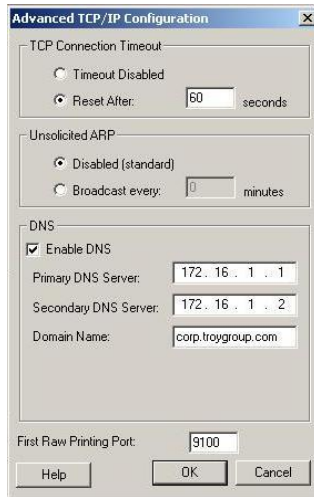

**Figure 16 Advanced TCP/IP Configuration Window**

5. Configure the settings, as defined in **Error! Reference source not found.**

**Table 19 TCP/IP Configuration Settings**

Parameter	Setting
TCP Connection Timeout	Sets the timeout and reset values for the TCP connections
Unsolicited ARP	Blocks or broadcasts unsolicited ARP
DNS	Sets the DNS addresses

6. To accept changes, click **OK**.  
To cancel, click **Cancel**.  
For additional help, click **Help**.

**NOTE:** You can configure the same settings using the Web Page configuration. Simply log in using the SX-560 IP address and select TCP/IP. For the changes to become effective, click the *Submit* button and then reset the SX-560.



## Configuring SNMP

The SX-560 module contains a Simple Network Management Protocol (SNMP) agent that collects and stores management information for network managers using standard SNMP commands. The management information is referenced as a hierarchically organized database called a Management Information Base (MIB).

To prevent naming conflicts, all of the manageable features of all products from all vendors are arranged in a single tree structure. Each vendor of SNMP equipment has an exclusive section of the MIB Tree.

Each branch of the MIB Tree has a number and name. The path from the top of the tree down to the point of interest forms the name of that point. A name created in this way is known as an Object ID or OID.

**Error! Reference source not found.** describes the messages used to communicate between the network manager and the SNMP agent, as defined in RFC 1157. Each SNMP message must contain a Community Name, which is used like a password. The default Community name for the SX-560 module is PUBLIC.

**Table 20 SNMP Commands**

Command	Description
GET	Retrieves management information for a specific managed object contained in the agent.  The GET message must contain the OID for the specified object. The response is a GET-RESPONSE message containing either the current value of the requested object, or an indication as to why the request failed.
GET NEXT	Retrieves management information from a non-specific managed object.  The GET NEXT contains either a complete OID or a fragment of an OID. The response is a GET-RESPONSE message containing either the OID and data of the item immediately right of the specified OID in the tree or an indication as to why the request failed.
GET RESPONSE	This is the information sent back from the unit in response to the GET, GET NEXT command.
SET	Requests a change to the value of a specified object.  The response is a GET-RESPONSE message with either an indication that the requested change had been made or with an indication as to why the request failed.
TRAP	Sends a one-way notification from the agent to the manager that a significant event has occurred. This is the only message initiated by the SNMP agent.

To configure the SNMP server settings:

6. Log into the SX-560 internal web pages using a standard web browser. Click **Server Settings** to access the screen shown in Figure 10. You can then enter the relevant SNMP information for your network.

The screenshot shows a web browser window with the URL <http://192.168.5.46/login>. The page title is "silix SX-500 WLAN". The main content area is titled "Server Settings" and contains a form with the following fields:

System Name	<input type="text" value="SLX386A43"/>	?
System Description	<input type="text" value="silix SX-500 WLAN"/>	?
System Contact	<input type="text"/>	?
System Location	<input type="text"/>	?
SNMP Get Community Name	<input type="text"/>	?
Confirm SNMP Get Community Name	<input type="text"/>	?
SNMP Set Community Name	<input type="text"/>	?
Confirm SNMP Set Community Name	<input type="text"/>	?
Restart the network interface.	<a href="#">Reset Server</a>	?
Restore configuration	<a href="#">Restore Defaults</a>	?

At the bottom of the form is a "Submit" button.

Below the form, there is a note: "The Configure Server Settings page lets you enter helpful information about your server. It also lets you set SNMP parameters for the server, reset the server, and restore the factory defaults of the server."

Under the heading "System Name", there is a description: "Enter a unique name for the server. This name can be up to 32 ASCII printable characters."

Figure 17 SNMP Configuration

7. Click the **Submit** button to save the changes. You must then restart the SX-560 to make the changes take effect.

## Configuring the General Purpose I/O (GPIO) Lines

The SX-560 module has eight General Purpose I/O (GPIO) lines available for use on connector J7. These GPIO lines are individually programmable for input, output, or special purpose. By default, six of the GPIO lines are configured for special purpose use.

Lines configured for input can be used as a source for SNMP traps. The GPIO direction, trigger settings, and web page message strings are configured from the Internal Configuration Console interface.

through 26 describe the GPIO Commands.

<b>Table 21 GPIO General Commands</b>																	
<b>Command</b>	<b>Description</b>																
<b>SET GPIO DIR [IN OUT] &lt;gpio-num&gt;</b> GPIO # = {1 2 3 4 5 6 7 8}	Sets GPIO signal to be an input or an output. The setting only takes effect if the GPIO signal is not selected for special function operation. <gpio-num> must be in the range 1-8.  NOTE: The direction bit configuration is not changed by a configuration reset to default.																
<b>SHOW GPIO DIR</b>	Shows current setting of the GPIO direction configuration.																
<b>Example:</b> <pre> Local&gt; show gpio dir  GPIO Direction ----- 1 [OUT] 2 [IN] 3 [IN] 4 [IN] 5 [SPCL] 6 [SPCL] 7 [SPCL] 8 [SPCL]  Local&gt; set gpio dir in 1  Local&gt; set gpio dir out 2  Local&gt; show gpio dir  GPIO Direction ----- 1 [IN] 2 [OUT] 3 [IN] 4 [IN] 5 [SPCL] 6 [SPCL] 7 [SPCL] 8 [SPCL] </pre>																	
<b>SET GPIO DIRM &lt;bit-mask&gt;</b> GPIO # = {1 2 3 4 5 6 7 8}	Sets all direction control bits, where <bit-mask> is an 8 bit mask expressed as 2 hex digits. This value should be in the range 00-FF. The mask is encoded as follows:  <div style="text-align: center;"> <table style="border: none; margin: auto;"> <tr> <td style="padding: 0 10px;">7</td> <td style="padding: 0 10px;">6</td> <td style="padding: 0 10px;">5</td> <td style="padding: 0 10px;">4</td> <td style="padding: 0 10px;">3</td> <td style="padding: 0 10px;">2</td> <td style="padding: 0 10px;">1</td> <td style="padding: 0 10px;">0</td> </tr> <tr> <td style="padding: 0 10px;">GPIO8</td> <td style="padding: 0 10px;">GPIO7</td> <td style="padding: 0 10px;">GPIO6</td> <td style="padding: 0 10px;">GPIO5</td> <td style="padding: 0 10px;">GPIO4</td> <td style="padding: 0 10px;">GPIO3</td> <td style="padding: 0 10px;">GPIO2</td> <td style="padding: 0 10px;">GPIO1</td> </tr> </table> </div> A value of 1 sets the corresponding GPIO line to be an output. A value of 0 sets the GPIO line to be an input. For example, a hex value of 80 sets GPIO8 as an output, all other GPIO signals are input.  NOTE: The direction bit configuration is not changed by a	7	6	5	4	3	2	1	0	GPIO8	GPIO7	GPIO6	GPIO5	GPIO4	GPIO3	GPIO2	GPIO1
7	6	5	4	3	2	1	0										
GPIO8	GPIO7	GPIO6	GPIO5	GPIO4	GPIO3	GPIO2	GPIO1										

Table 21 GPIO General Commands	
Command	Description
	configuration reset to default.
SHOW GPIO DIRM <bit-mask>	Shows all direction control bits
<p>Example:</p> <pre> Local&gt; set gpio dirm 01  Local&gt; show gpio dirm  GPIO direction mask=01 </pre>	
SET GPIO SPECIAL [EN   DIS]	<p>Sets a single special function control bit. This command enables or disables the special function of the GPIO signal specified. &lt;gpio-num&gt; must be in the range of 1-8. The special functions are as follows:</p> <pre> GPIO_1    (no special function) GPIO_2    (SPI CS for LCD display) GPIO_3    TSPICS (enables SPI temperature) GPIO_4    DTR0 (Serial Port 1 DTR output) GPIO_5    DSR0 (Serial Port 1 DSR input) GPIO_6    DCD0 (Serial Port 1 DCD input) GPIO_7    GRN (network status LED) GPIO_8    YEL (network status LED) </pre> <p>NOTE: The special function bit configuration is not changed by a configuration reset to default.</p>
SHOW GPIO SPECIAL	Shows the current setting of the GPIO special function configuration.
<p>Example:</p> <pre> Local&gt; show gpio special  GPIO Special Functions ----- GPIO #1 is special GPIO #2 is normal GPIO #3 is special GPIO #4 is special GPIO #5 is special GPIO #6 is special GPIO #7 is special GPIO #8 is special  Local&gt; set gpio special disable 1  Local&gt; set gpio special enable 2  Local&gt; show gpio special  GPIO Special Functions ----- </pre>	

Table 21 GPIO General Commands	
Command	Description
GPIO #1 is normal GPIO #2 is special GPIO #3 is special GPIO #4 is special GPIO #5 is special GPIO #6 is special GPIO #7 is special GPIO #8 is special	
<b>SET GPIO SPECM &lt;bit-mask&gt;</b>	<p>Sets all special function control bits. &lt;bit-mask&gt; is an 8-bit mask expressed as 2 hex digits. This value should be in the range 00-FF. The mask is encoded as follows:</p> <pre>       7   6   5   4   3   2   1   0 GPIO8 GPIO7 GPIO6 GPIO5 GPIO4 GPIO3 GPIO2 GPIO1 </pre> <p>A value of 1 enables the special function on the corresponding GPIO signal, a value of 0 disables the special function. For example, a hex value of 80 sets GPIO8 for a special function, all other GPIO signals for general use.</p> <p>NOTE: The special function bit configuration is not changed by a configuration reset to default. This command has no effect on GPIO 1 and 2, which do not have special functions.</p>
<b>SHOW GPIO SPECM</b>	<p>Shows GPIO special functions control bits as a mask value.</p>
<b>Example:</b> <pre> Local&gt; set gpio specm 80  Local&gt; show gpio specm  GPIO special function mask=80 </pre>	

**Table 22 GPIO Trigger Commands**

Command	Description
SET GPIO TRIGger [1   0  DIS] <gpio-num>	<p>Sets a single control bit. The setting only takes effect if the GPIO signal is not selected for a special function operation and is configured to be an input. The parameter after the TRIG keyword controls the operation as follows:</p> <p>Enable trigger if the specified GPIO signal transitions from a 0 to a 1.</p> <ul style="list-style-type: none"> <li>1 Enable trigger if the specified GPIO transitions from a 1 to a 0</li> <li>0 Enable trigger if the specified GPIO transitions from a 0 to a 1</li> <li>DIS Disable all triggers for the specified GPIO signal.</li> </ul> <p>&lt;gpio-num&gt; must be in the range 1-8.</p> <p>NOTE: Setting a trigger condition resets all undefined trigger strings for triggers that are enabled to the default string value.</p> <p>NOTE: The trigger configuration is not changed by a configuration reset to default.</p>
SHOW GPIO TRIGger	<p>Shows current GPIO trigger conditions. Note that a GPIO may be enabled for two trigger conditions, one for a 0 to 1 transition, and one for a 1 to 0 transition. If a GPIO is set for its special function, no trigger is possible on that pin.</p>
<p>Example:</p> <pre> Local&gt; set gpio trig 1 1  Local&gt; set gpio trig 0 2  Local&gt; show gpio trig  GPIO Trigger Conditions ----- trig if GPIO #1 is 1 &lt;Trig #1&gt; trig if GPIO #2 is 0 &lt;Trig #2&gt;  GPIO #2 is set for OUTPUT GPIO #3 is set for OUTPUT           </pre>	

**Table 22 GPIO TRIGM Commands**

Command	Description																																																																																																
SET GPIO TRIGM <bit-mask>	<p>Sets all trigger control bits. &lt;bit-mask&gt; is a 32-bit mask expressed in hex digits. The mask is encoded as follows:</p> <table border="1" data-bbox="779 409 1404 672"> <tr> <td>31</td><td>30</td><td>29</td><td>28</td><td>27</td><td>26</td><td>25</td><td>24</td> </tr> <tr> <td>N/A</td><td>N/A</td><td>N/A</td><td>N/A</td><td>N/A</td><td>N/A</td><td>N/A</td><td>N/A</td> </tr> <tr> <td>23</td><td>22</td><td>21</td><td>20</td><td>19</td><td>18</td><td>17</td><td>16</td> </tr> <tr> <td>TRIG16</td><td>TRIG15</td><td>TRIG14</td><td>TRIG13</td><td>TRIG12</td><td>TRIG11</td><td>TRIG10</td><td>TRIG9</td> </tr> <tr> <td>GPIO8</td><td>GPIO7</td><td>GPIO6</td><td>GPIO5</td><td>GPIO4</td><td>GPIO3</td><td>GPIO2</td><td>GPIO1</td> </tr> <tr> <td>1 to 0</td><td>1 to 0</td><td>1 to 0</td><td>1 to 0</td><td>1 to 0</td><td>1 to 0</td><td>1 to 0</td><td>1 to 0</td> </tr> <tr> <td>15</td><td>14</td><td>13</td><td>12</td><td>11</td><td>10</td><td>9</td><td>8</td> </tr> <tr> <td>N/A</td><td>N/A</td><td>N/A</td><td>N/A</td><td>N/A</td><td>N/A</td><td>N/A</td><td>N/A</td> </tr> <tr> <td>7</td><td>6</td><td>5</td><td>4</td><td>3</td><td>2</td><td>1</td><td>0</td> </tr> <tr> <td>TRIG8</td><td>TRIG7</td><td>TRIG6</td><td>TRIG5</td><td>TRIG4</td><td>TRIG3</td><td>TRIG2</td><td>TRIG1</td> </tr> <tr> <td>GPIO8</td><td>GPIO7</td><td>GPIO6</td><td>GPIO5</td><td>GPIO4</td><td>GPIO3</td><td>GPIO2</td><td>GPIO1</td> </tr> <tr> <td>0 to 1</td><td>0 to 1</td><td>0 to 1</td><td>0 to 1</td><td>0 to 1</td><td>0 to 1</td><td>0 to 1</td><td>0 to 1</td> </tr> </table> <p>A value of 1 enables the corresponding GPIO trigger condition. A value of 0 disables the corresponding trigger condition. For example, a hex value of 4 enables a GPIO3 0 to 1 transition as a trigger.</p> <p>NOTE: Setting the trigger mask resets all undefined trigger strings for triggers that are enabled to the default trigger string value.</p> <p>NOTE: The trigger configuration is not changed by a configuration reset to default.</p>	31	30	29	28	27	26	25	24	N/A	N/A	N/A	N/A	N/A	N/A	N/A	N/A	23	22	21	20	19	18	17	16	TRIG16	TRIG15	TRIG14	TRIG13	TRIG12	TRIG11	TRIG10	TRIG9	GPIO8	GPIO7	GPIO6	GPIO5	GPIO4	GPIO3	GPIO2	GPIO1	1 to 0	1 to 0	1 to 0	1 to 0	1 to 0	1 to 0	1 to 0	1 to 0	15	14	13	12	11	10	9	8	N/A	N/A	N/A	N/A	N/A	N/A	N/A	N/A	7	6	5	4	3	2	1	0	TRIG8	TRIG7	TRIG6	TRIG5	TRIG4	TRIG3	TRIG2	TRIG1	GPIO8	GPIO7	GPIO6	GPIO5	GPIO4	GPIO3	GPIO2	GPIO1	0 to 1	0 to 1	0 to 1	0 to 1	0 to 1	0 to 1	0 to 1	0 to 1
31	30	29	28	27	26	25	24																																																																																										
N/A	N/A	N/A	N/A	N/A	N/A	N/A	N/A																																																																																										
23	22	21	20	19	18	17	16																																																																																										
TRIG16	TRIG15	TRIG14	TRIG13	TRIG12	TRIG11	TRIG10	TRIG9																																																																																										
GPIO8	GPIO7	GPIO6	GPIO5	GPIO4	GPIO3	GPIO2	GPIO1																																																																																										
1 to 0	1 to 0	1 to 0	1 to 0	1 to 0	1 to 0	1 to 0	1 to 0																																																																																										
15	14	13	12	11	10	9	8																																																																																										
N/A	N/A	N/A	N/A	N/A	N/A	N/A	N/A																																																																																										
7	6	5	4	3	2	1	0																																																																																										
TRIG8	TRIG7	TRIG6	TRIG5	TRIG4	TRIG3	TRIG2	TRIG1																																																																																										
GPIO8	GPIO7	GPIO6	GPIO5	GPIO4	GPIO3	GPIO2	GPIO1																																																																																										
0 to 1	0 to 1	0 to 1	0 to 1	0 to 1	0 to 1	0 to 1	0 to 1																																																																																										
SHOW GPIO TRIGM	Shows all trigger control bits.																																																																																																
<p>Example:</p> <pre> Local&gt; set gpio trigm 00040006  Local&gt; show gpio trigm  GPIO trigger mask = 00040006 </pre>																																																																																																	

**Table 23 GPIO Transmit Commands**

Command	Description
SET GPIO TRANsmit <trigger #> <string>	<p>Sets the string that will be used to identify the trigger on the trap and alert web pages. This value overrides the default string created when the trigger is enabled, which is of the form "GPIO #&lt;n&gt; is 0 1&gt;".</p> <p>&lt;trigger #&gt; is 1-16, and indicates the trigger condition for which the string is being set. The remainder of the line is taken as the string for the indicated trigger number.</p>
SHOW GPIO TRANsmit SHOW GPIO TRANsmit <trigger #>	<p>Displays the string that will be used to identify the trigger on the trap and alert web pages. There are two forms -- one displays all strings, the other only shows the string corresponding to a specific trigger.</p>
CL GPIO TRANsmit <trigger #>	<p>Clears the transmit string for a specified trigger condition.</p> <p>&lt;trigger #&gt; is 1-16, and indicates the trigger condition for which the string is being cleared.</p> <p>NOTE: If a new trigger condition is set, all undefined trigger conditions are reset to their default value.</p>

**Example:**

```

Local> show gpio tran

Trig #   Email String
-----   -
0:       GPIO #1 is 1
1:       GPIO #2 is 1

Local> set gpio tran 0 your text msg here

Local> show gpio tran

Trig #   Email String
-----   -
0:       your text msg here
1:       GPIO #2 is 1

Local> show gpio tran 1
1: GPIO #1 is 1

```



**Table 24 GPIO Data Commands**

Command	Description
SET GPIO DATA <bit-mask>	<p>Sets all the data out control bits.</p> <p>&lt;bit-mask&gt; is an 8 bit mask expressed as 2 hex digits. This value should be in the range 00-FF. The mask is encoded as follows:</p> <pre> 7       6       5       4       3       2       1       0 GPIO8  GPIO7  GPIO6  GPIO5  GPIO4  GPIO3  GPIO2  GPIO1 </pre> <p>Each GPIO output bit is set to the corresponding value in the mask. If a GPIO signal is set as an input, the value is set but has no effect. If a GPIO signal is set for a special function, the bit value give is ignored. For example, a hex value of 80 sets GPIO8 to a 1 (high), all other GPIO signals to low, except those set as special functions.</p> <p>NOTE: The default output bit value on power up or reset is 0 for all GPIO signals.</p>
SHOW GPIO DATA	Shows the current state of the GPIO signals.
<p>Example:</p> <pre> Local&gt; set gpio data 80  Local&gt; show gpio data  GPIO Data In ----- GPIO #1 [1] GPIO #2 [1] GPIO #3 [0] GPIO #4 [1] GPIO #5 [1] GPIO #6 [1] GPIO #7 [0]  GPIO Data Out ----- GPIO #8 [1] </pre>	

Table 25 E-GPIO TCP Monitor Commands

The E-GPIO TCP monitor allows a computer system to access the SX-560 GPIO pin values. If enabled, this monitor will attempt to make a TCP connection to the remote computer specified. Once connected, the monitor will periodically send the state of the GPIO pins to the remote computer. This monitor is configured via the console with the following commands:

Command	Description
SET GPIO MON [EN   DIS]	Enables or disables the E-GPIO monitor
SHOW GPIO MON	Shows the current state of the GPIO monitor.
SET GPIO ADDR <ip address>	Sets the IP address of the remote computer for E-GIO connection
SET GPIO PORT	Sets the TCP port on the remote computer for E-GPIO connection.
SET GPIO POLL <period>	<p>Sets E-GPIO poll period. When not connected, this controls how often the E-GPIO monitor attempts to make a connection to the remote computer. When connected, this indicates how often the E-GPIO monitor will send the GPIO state to the remote computer.</p> <p>&lt;period&gt; is the time interval in milliseconds. Note that this interval will be rounded to the system clock resolution (10msec). A value less than a single clock period will result in the default value of 5000 (5 seconds) being used.</p>
GPIO status message format	<p>The periodic message sent by the E-GPIO monitor is a simple text string in the following format:</p> <p>GPIO=00ab&lt;LF&gt;</p> <p>Where ab are 2 hex digits representing the state of the GPIO pins. Since there are only 8 GPIO pins on the SX-560, the first two digits are always 0. The message is sent every n milliseconds, where n is the poll period set by the SET GPIO POLL command.</p>

Table 25 E-GPIO TCP Monitor Commands

<p>GPIO set message format</p>	<p>This message may be optionally sent by the remote computer when an E-GPIO connection is active. This message allows the remote computer to set the state for any GPIO pins configured as outputs. This is equivalent to the SET GPIO DATA command.</p> <p>The message is in the format:</p> <p>GPIO=00ab&lt;LF&gt;</p> <p>Where <i>ab</i> are 2 hex digits representing the state of the GPIO pins. Since there are only 8 GPIO pins on the SX-560, the first two digits should always be 0. Any other message sent to the E-GPIO connection is ignored. If the message is formatted incorrectly, it is ignored.</p>
<p>Example:</p> <pre> Local&gt; set gpio mon en  Local&gt; set gpio addr 192.168.1.100  Local&gt; set gpio port 9999  Local&gt; set gpio poll 100  Local&gt; sh gpio mon  E-GPIO mode Enabled E-Cable destination 192.168.1.100 Poll interval 100 milliseconds Not connected </pre>	

Table 26 GPIO SNMP Management

The GPIO pins can also be managed via SNMP. The available MIB items are described in this section. The GPIO related MIB items are in the Silex private MIB, and the GPIO tree is at `gpio=enterprises.1240.2.3.4.9`.

GPIO bit mask

Integer read-only gpio.1

This is an integer representing a bit mask indicating what GPIO pins are available. There is a 1 for each GPIO pin that is present. For the SX-560, this value is 255 (xFF), indicating 8 GPIO pins.

GPIO direction control

Integer read-only gpio.2

This is an integer representing a bit mask indicating which GPIO bits are configured for outputs. Only bits for which the GPIO bit mask is 1 are valid. A 1 indicates the GPIO bit is an output, a 0 indicates an input.

7	6	5	4	3	2	1	0
GPIO8	GPIO7	GPIO6	GPIO5	GPIO4	GPIO3	GPIO2	GPIO1

GPIO data

Integer read-write gpio.2

This is an integer representing a bit mask indicating the GPIO bits status. On a read, the current value of the input pins is returned. Output bits return the last value set. On a write, bits configured as outputs are set to the value given by the corresponding mask bit. For input bits, a write has no effect.

7	6	5	4	3	2	1	0
GPIO8	GPIO7	GPIO6	GPIO5	GPIO4	GPIO3	GPIO2	GPIO1

GPIO trigger mask

Integer read-only gpio.2

This value is an integer representing a 32 bit mask expressed in hex digits. The mask is encoded as follows:

31	30	29	28	27	26	25	24	23	22	21	20	19	18	17	16
N/A	N/A	N/A	N/A	N/A	N/A	N/A	N/A	TRIG16	TRIG15	TRIG14	TRIG13	TRIG12	TRIG11	TRIG10	TRIG9
								GPIO8	GPIO7	GPIO6	GPIO5	GPIO4	GPIO3	GPIO2	GPIO1
								1 to 0	1 to 0	1 to 0	1 to 0	1 to 0	1 to 0	1 to 0	1 to 0
15	14	13	12	11	10	9	8	7	6	5	4	3	2	1	0
N/A	N/A	N/A	N/A	N/A	N/A	N/A	N/A	TRIG8	TRIG7	TRIG6	TRIG5	TRIG4	TRIG3	TRIG2	TRIG1
								GPIO8	GPIO7	GPIO6	GPIO5	GPIO4	GPIO3	GPIO2	GPIO1
								0 to 1	0 to 1	0 to 1	0 to 1	0 to 1	0 to 1	0 to 1	

A value of 1 indicates the corresponding GPIO trigger condition is enabled. A value of 0 indicates the corresponding GPIO trigger condition is disabled. For example a hex value of 4 represents GPIO3 0 to 1 transition (TRIG3) is enabled as a trigger.

Table 26 GPIO SNMP Management

GPIO transmit string table index

Integer          read-only          gpio.5.1.1.n

This value is the index into the GPIO message table for trigger number n. For the SX-560, this always returns n as its value.

GPIO transmit string value

Octet-string      read-only          gpio.5.1.2.n

This item returns the GPIO transmit string for trigger number n, if a string is defined. The string may be defined even if the corresponding trigger is not currently enabled.

## Configuring Serial Port Monitor Alert and Trap Configuration

The SX-560 module can be configured to scan and compare the data received on the serial port to user-defined strings. A match with a string can be a source for SNMP traps.

The match strings and corresponding web page message strings are configured from the Internal Configuration Console interface.

**Error! Reference source not found.** describes the Monitor Alert and Trap Configuration Commands (the examples are for serial port 1; for serial port 2, substitute the port name S2 instead of S1).

**Table 27 Port Monitor Alert Commands**

Command	Description
SHOW PORT S1 TRIGMON	Shows strings and index numbers being monitored
SET PORT S1 TRIGMON <trig #> <string>	Assigns a string to be monitored on the serial port
<p>Example:</p> <pre> Local&gt; show port s1 trigmon  Index #  Monitor String -----  - Local&gt; set port s1 trigmon 0 trigger on seeing this string Local&gt; show port s1 trigmon  Index #  Monitor String -----  - 0:      trigger on seeing this string </pre>	
SHOW PORT S1 TRIGXMT	Shows web page strings associated with TRIGMON index numbers
SET PORT S1 TRIGXMT <index #> <string> Index # = 0 to 7	Assigns web page string to specified TRIGMON index number
<p>Example:</p> <pre> Local&gt; show port s1 trigxmt  Index #  Xmit String -----  - 0:      xmit string 0    &lt;&lt;&lt; default msg string  Local&gt; set port s1 trigxmt 0 The trigger string was seen! Local&gt; show port s1 trigxmt  Index #  Xmit String -----  - 0:      The trigger string was seen! </pre>	

## Setting up SNMP Traps

After you have created the GPIO and/or Serial Port alerts and traps, you can use the SX-560 internal web pages to set up the recipient computer systems. After you have logged into the internal web pages, click **Alerts and Traps** on the left side of the screen and select **SNMP IP Traps**.

The SNMP Trap Configuration page allows you to define up to eight destinations for trap messages. For each entry, you enter the Trap Community plus the IP address and port of the destination computer(s). Up to eight separate IP addresses can be configured with any combination of the alerts that you have defined. Note that you may also use the console command SET IP TRAP n TRIGGER console command (see appendix B) to set up the traps.

When you have finished configuring the alerts, be sure to click the **Submit** button to save the settings. You will also need to restart the SX-560 in order for the changes to take effect.

## Using AT Modem Commands

The SX-560 firmware has an optional data filter for configuring using AT style modem commands with serial port 1. This feature allows devices with an existing AT command interface to configure the unit, if the AT commands can be properly modified. You must be familiar with the general operation of AT commands. Note that AT command processing is not enabled by default. Use the command SET PORT S1 FILTER AT to enable this feature.

All commands begin with AT and are terminated by a new line unless noted below. While standard AT commands are defined to be 40 characters or less (not including the AT), the server accepts commands of up to 80 characters.

### Standard AT Commands Supported

The following standard AT commands are interpreted by the device server. The data channel must be in the command mode for commands to be recognized. The data channel will be in command mode upon power up or reset.

There are two operating modes for the unit when the AT command option is enabled. In command mode, data received from the serial port is passed to the AT command processor, and responses are returned to the serial port. No data is sent to any network application, and any data received from the network is ignored. In data mode, data from the serial port passes to the network application, and vice versa. This is equivalent to the normal serial port operating mode without the AT command option.

describes the AT Commands. **Error! Reference source not found.** details the Extended AT Commands that allow the configuration of the network server operating parameters. Any AT command received, except the listed commands, are acknowledged with OK status. This allows existing modem applications to transmit commands without causing an error. These include AT<X>n, but not currently AT&<X>n, AT%<X>n, AT\<X>n, where <X> is a letter.

Parameter	Command	Description
Enter Command mode	<delay>+++<delay>	If the string +++ is seen in data mode, with no characters sent for 1 second before or after, then command mode is entered.

**Table 28 AT Commands**

Parameter	Command	Description
Initiate Connection Command	ATD <destination>	<p>Standard modem dialing command, redefined to initiate an internet connection to a remote computer.</p> <p>Indicates the IP address of the target, and optionally the TCP port number to use for connection. The T or P option (ATDT or ATDP) can be present and has no effect.</p> <p>If present, the IP address must be exactly 12 decimal digits with 3 for each byte of the address.</p> <p>If no IP address is given, then the ecable destination address defined for the port is used.</p> <p>If the destination TCP port is defined, it is separated from the IP address by a '#' character, and is 1 to 5 decimal digits.</p> <p>If TCP port is defined, the ECable destination port defined for the serial port is used. If the destination port is 0, the standard Telnet port (23) is used.</p> <p>If the destination string ends with a semicolon, the server remains in the command mode, not the data mode, once a connection is made.</p> <p>In command mode data is not passed from the remote computer, so data could be lost if the unit stays in command mode.</p> <p>If the connection cannot be attempted, NO CARRIER status is returned. If the connection attempt fails, NO ANSWER status is returned.</p> <p>If the connection succeeds, CONNECT status is returned.</p>
Echo control	ATEn	<p>If n=0, commands are not echoed.</p> <p>If n=1, subsequent commands will be echoed.</p> <p>The default, upon unit reset, is for no echo (ATE0).</p>
Disconnect	ATHn	<p>If n=0, any connection to a remote host is dropped. Other value of n is ignored.</p>
Return to data mode	ATOn	<p>Exits command mode and places the serial port in the data mode.</p> <p>All subsequent data is sent to the network application, if connected, until an enter command mode sequence is received. Any value of n is ignored, if present.</p>
Quiet mode	ATQn	<p>If n = 1, no result codes are returned.</p> <p>If n = 0, result codes are returned to the local device. 0 is the reset default value.</p>
Verbose mode	ATVn	<p>If n = 0 and not in quiet mode, result codes are returned in numerical form.</p> <p>If n = 1, results are returned as text. 1 is the reset default value.</p>



**Table 29 Extended AT Commands**

Parameter	Command	Description
Console pass through	AT#C<string>	<p>Passes the string to the server configuration console. The string can be any valid console command. Refer to your server documentation for console commands available on your unit.</p> <p>Since this command does not follow the normal AT command format of &lt;command&gt;&lt;number&gt;, it must be the last command on the line unless the next command is a '#' command. All characters up to the end of line or a '#' will be considered part of the console command.</p> <p>If console quiet mode is not is enabled, then the response will be the standard console task response.</p> <p>Example:</p> <pre>AT#Cset nw ssid silex#Csave</pre>
Console Quiet mode	AT#Qn	<p>If n = 0, a response to a #C command is given.</p> <p>If n = 1, the response is not provided. The default after reset is 1.</p>

## Response Codes

**Error! Reference source not found.** details the response codes for codes other than #C commands.

**Table 30 Response Codes**

Numeric Code	Description
0	OK
2	No Carrier
4	Error
5	Connect
8	No Answer

## Using ExtendView for Bulk Configuration

The ExtendView Utility has a powerful bulk configuration capability that allows you download configuration information to multiple SX-560s simultaneously. This can save you a significant amount of time compared to configuring each SX-560 individually. To use this capability:

1. From the ExtendView menu bar, select **View** and then **Multi-Select Mode**.
2. The display will change slightly so that there is checkbox by each of the SX-560s listed on the main screen. Click the boxes next to each of the SX-560s that you wish to configure.
3. From the ExtendView menu bar, select **Server** and then **Multiple Configuration**. The Configure Multiple Devices window will appear. This Window lets you set parameters such as subnet mask, router address, basic wireless security, and much more. When you have set all of the desired parameters, click OK and the parameters will be downloaded into the selected SX-560s.

## Chapter 7 Product Specifications

**Table 31 Product Specifications**

Component	Specifications
Model	SX-560 Module
Dimensions	34.3 x 49.5 x 9.65 mm (1.35 x 1.95 x 0.38 inches)
Processor	Samsung S3C2412 (ARM9 32-bit RISC)
RAM Memory	16 Mbytes SDRAM.
Processor Speed	200 MHz at full power
Radio/Baseband	Atheros AR6001XL(1701) / AR60002XL(2701)
Interfaces Supported	Serial: 3 x UART (RS-232 w/ external transceivers); one port is dedicated as a console port USB 1.1 (12Mbps) host interface Serial Peripheral Interface (up to 25MHz) IIC (requires user-written driver and support chip)

**Table 32 Radio Specifications**

Parameter	Specifications
Radio Emission Type	Complies with IEEE 802.11a, b, g, h and j Direct Sequence Spread Spectrum (DSSS) physical layer.
Operating Frequency	2.412 GHz ~ 2.484 GHz ISM band 5.15 GHz ~ 5.35 GHz ISM band 5.725 GHz ~ 5.825 GHz ISM band
Data Modulation Type	Orthogonal Frequency Division Multiplexing (OFDM) Complementary Code Keying (CCK) Differential Quadrature Phase Shift Keying (DQPSK) Differential Binary Phase Shift Keying (DBPSK)

<b>Table 32 Radio Specifications</b>	
<b>Parameter</b>	<b>Specifications</b>
Channel Number	IEEE 802.11b and g: Channels 1 to 11 and 12 to 14*  IEEE 802.11a: Channels 36, 40, 44, 48, 52*, 56*, 60*, 64*, 100*, 104*, 108*, 112*, 116*, 120*, 124*, 128*, 132*, 136*, 140*, 149, 153, 157, 161, 165  * Channels 12-14, 52-64, 100-140 are not available in the United States and Canada.
Data Rate	54 Mbps with fallback rates of 48, 36, 24, 18, 12, 11, 9, 6, 5.5, 2, and 1 Mbps
Security	WEP64/128, TKIP, AES
Media Access Protocol	Carrier Sense Multiple Access with Collision Avoidance (CSMA/CA) with ACK architecture, 32 bits MAC-layer.
Antenna Connector Type	2 SMT ultra-miniature coaxial connectors
Operating Voltage	3.3 VDC
Bus Interface	SDIO

## TCP Port Connections

The SX-560 module supports port connections over TCP/IP using raw TCP ports only. **Error! Reference source not found.** describes the TCP ports allocations.

**Table 33 TCP Port Connections**

<b>Port</b>	<b>Destination Device</b>
3001	RS-232 Serial Port 1 (S1)
9100	RS-232 Serial Port 1 (S1)
9200	RFC 2217 Serial Port 1 (S1)
3002	RS-232 Serial Port 2 (S2)
9101	RS-232 Serial Port 2 (S2)
9201	RFC 2217 Serial Port 2 (S2)

## Appendix A

# Advanced Security Configuration

There are numerous possible security settings. It is therefore important that you verify the appropriate settings with your network administrator. If you enter the settings incorrectly, the SX-560 will not be able to communicate on your network. The following table summarizes the wireless settings required for each encryption mode and authentication type:

		Authentication Type							
		Open System	Shared-Key	PSK	802.1x				
					TTLS	LEAP	PEAP	TLS	EAP-FAST
Encryption Mode	Disable	(OK)	N/A	N/A	N/A	N/A	N/A	N/A	N/A
	64-Bit WEP	1	1	N/A	N/A	N/A	N/A	N/A	N/A
	128-Bit WEP	1	1	N/A	N/A	N/A	N/A	N/A	N/A
	WPA	N/A	N/A	2, 3	4, 7	4	4, 5	4, 5, 6	4
	WPA2	N/A	N/A	2, 3	4, 7	4	4, 5	4, 5, 6	4
	WPA2-WPA	N/A	N/A	2, 3	4, 7	4	4, 5	4, 5, 6	4
	Dynamic WEP	N/A	N/A	N/A	4, 7	4	4, 5	4, 5, 6	4

Basic Configuration Parameters
1. 64/128Bit WEP Key
2. WPA-PSK
3. WPA Group Key

802.1X Configuration Parameters
4. User ID and Password
5. Authentication Server Certificate
6. Private Key
7. Authentication Protocol

To use the above table, select the encryption mode and authentication type you are using. For example, if you are using WPA2 with PSK authentication, you would need to set the WPA-PSK pre-shared key and enable or disable the WPA Group Key. Likewise, if you are using WPA2 with 802.1X TLS authentication, you would need to enter a User ID and Password, an Authentication Certificate, and a Private Key.

The following is a description of the authentication settings used by the SX-560:

### Encryption Mode

The possible SX-560 wireless encryption modes include:

- *64 and 128 bit WEP.* These are available for basic WIFI compatibility. Because of known security issues, WEP should be avoided if possible.

- *Dynamic WEP*. Dynamic WEP uses WEP encryption with an 802.1X EAP authentication method. It is not necessary to set keys with this method, because they are automatically assigned.
- *WPA2*. WPA2 is the latest and strongest wireless security standard. It uses CCMP encryption. Like WPA, it can be used either with a pre-shared key or with 802.1X authentication.
- *Wi-Fi Protected Access (WPA)*. WPA uses TKIP encryption, and can be used with either a pre-shared key (PSK) or with 802.1X authentication.
- *WPA2-WPA*. This mode combines the capabilities of WPA2 and WPA by using CCMP for pairwise encryption, but allowing TKIP for group encryption.

To set the encryption mode, select the desired mode from the pull down menu on the Configure Network Security screen in the SX-560 internal web pages, or use the console command SET NW ENC <mode>, where <mode> is DISABLE, 64, 128, WPA, OR WPA2.

Note that the encryption mode only applies to wireless networks, so it is not necessary to set this mode if you are using a wired Ethernet network.

### Key Selection

This parameter selects which of the four possible WEP keys will be used as the transmit key (the first key is the default). Select the desired key selection from the pull down menu on the Configure Network Security screen in the SX-560 internal web pages, or use the console command SET NW KEY# *n*, where *n* is 1, 2, 3, or 4.

### WEP Key Value

Up to four keys can be entered if you are using WEP security. The value of the keys must be entered as hexadecimal digits (up to 10 hex digits for 64 bit WEP or 26 hex digits for 128 bit WEP). Enter the desired key value(s) on the Configure Network Security screen in the SX-560 internal web pages, or use the console command SET NW KEYVAL <key>, where <key> is 10 hex digits for WEP64 or 26 hex digits for WEP128.

### Pre-Shared Key

If you are using WPA2 or WPA with the PSK mode of authentication, the key value or passphrase entered here is used to initialize the session with the access point. If a key value is entered, it must be exactly 64 hex characters. A passphrase must be 8 to 63 displayable characters. Enter the desired PSK on the Configure Network Security screen in the SX-560 internal web pages, or use the console command SET NW WPAPSK <psk>, where <psk> is the key.

### Wireless Authentication Type

This parameter sets the type of authentication to be performed with the network access point (Radius authentication server), or with a peer unit in Ad Hoc mode. The SX-560 supports Shared Key and Open System Authentication with WEP, and PSK, TLS, TTLS, LEAP, PEAP, and EAP-FAST with WPA, WPA2, DYNAMIC WEP, and WPA2-WPA. ). Select the desired wireless authentication type on the Configure Network Security screen in the SX-560 internal web pages, or use the console command SET NW AUTHTYPE <type>, where <type> is OPEN, SHARED, TTLS, PEAP, WPA-PSK, LEAP, TLS, or EAP-FAST.

### User ID

This parameter is the logon user ID that the SX-560 uses to authenticate to the 802.1x-enabled network. The user ID and password must be in the authentication server database. The default user ID is 'anonymous'. Enter the user ID on the Configure Network Security screen in the SX-560 internal web pages, or use the console command SET NW ID <user id>, where <user id> is the user ID (the realm can be included in the user id with the separator "@").

### Realm

A realm defines a grouping of users. If a realm is required for your network, it is separated from the user ID by a '@' character. A realm makes it easier to segregate user groups into independently administered databases, to apply policies on a user group basis, and to establish roaming agreements. The default realm if not specified is 'anonymous'. Enter the realm on the Configure Network Security screen in the SX-560 internal web pages, or use the console command SET NW REALM <realm>, where <realm> is the name of the realm.

### Password

This parameter is the logon password that the server uses to authenticate to the 802.1x-enabled network. The user ID and password must be in the authentication server database. The password may be a text string, or a string of hex bytes. Enter the password on the Configure Network Security screen in the SX-560 internal web pages, or use the console command SET NW PW <password>, where <password> is the password (default value is *anonymous*).

### **Authentication Protocol**

This parameter determines how the server authenticates itself to the 802.1x-enabled network after an 802.1x session is established. The default is PAP; MSCHAP\_V2 is the alternative protocol. Select the desired protocol on the Configure Network Security screen in the SX-560 internal web pages, or use the console command SET NW INAP <password>, where <password> is PAP or MSCHAP\_V2.

### **Authentication Certificate**

Authentication certificates are used by TLS and PEAP. You can enter the certificate from a file on your disk using the SX-560 web browser interface as follows:

1. Log into the web browser interface as described in Chapter 3
2. Click **Wireless** on the left side of the screen
3. Click **Configure Network Security**
4. Click **Configure Authentication Server Certificate**
5. Click **Browse** and select the file on your computer that contains the certificate
6. Click **Submit**

### **Private Key (TLS Wireless Security Only)**

Private key information or the corresponding public key certificate for the SX-560 can be loaded from disk (Private Key Information File) or manually entered. If the file is encrypted, you must enter the passphrase in the passphrase entry field on the Configure Private Key page in the internal web pages of the SX-560 (NOTE: At present, only PEM format files are supported). To manually generate a self-signed certificate for the SX-560, the following information is required:

- **Certificate Common Name**
- **Organization name**
- **Organization unit**
- **City name**
- **State name**
- **Country name**
- **Key Size (1024 or 2048)**

You may enter this information on the Configure Private Key page in the internal web pages of the SX-560 (it cannot be entered via console commands).

# Appendix B

## Console Commands

The following tables describe the console commands available from the internal command console. Access the command console through Serial Port 1, Serial Port 2, the console port, or over the network using a Telnet session or a web browser (use the SX-560 Console Mode Switching or AT commands as described in Chapter 6 to send console commands to Serial Port 1 and Serial Port 2).

### Wireless and Network Security Commands

The following group of commands configures network parameters.

Table 34 Network Commands	
Command	Description
SH NW	Displays summary network information  Sample output: WiFi Mode = INFRASTRUCTURE WiFi SSID: silex Speed = 11 Regulatory Domain = 704 WiFi FW Ver = 1F 1.7.1 AP density = LOW TTLS is Disabled WEP is Disabled Link DOWN
SH NW SQ	Display wireless network signal quality  Sample Output:: Signal Quality = 97 Signal Strength = -41 Noise Level = -95

**Table 34 Network Commands**

Command	Description
SET NW AUTHtype	Sets wireless authentication type The default value is Open System Format: <pre>SET NW AUTHtype [OPEN   SHARED   TTLS   LEAP   PEAP   TLS   FAST   WPA-PSK ]</pre>
SH NW AUTH	Shows wireless authentication type Sample output: <pre>Authentication type= OPEN SYSTEM</pre>
SET NW AUTHTRY	Sets number of times the SX-560 will attempt to authentication The default value is 0. Format: <pre>SET NW AUTHTRY n</pre>
SH NW AUTHTRY	Shows number of authentication tries. Sample output: <pre>Authentication Try Count = 3</pre>
SET NW CHannel	Sets WLAN ad-hoc channel number The valid numbers are 1 through 11. Format: <pre>SET NW CHannel n</pre>
SET NW ENC	Sets WLAN Encryption Mode. Supported modes are None, 64 bit WEP, 128 bit WEP, WPA, WPA2, WPA2-WPA The default value is Disable. Format: <pre>SET NW ENC [Disable   64   128   WPA   WPA2 ]</pre>
SH NW ENC	Shows the wireless encryption mode The deprecated command SH NW WEP also displays this information. Sample output: <pre>WiFi encryption is Disabled</pre>
SET NW KEY#	Selects the WLAN WEP key entry (the WEP key that will be used as the transmit key) The possible values are 1, 2, 3, or 4; the default value is 1. Format: <pre>SET NW KEY# n</pre>
SET NW KEYVAL	Sets the WLAN WEP key entry to the specified hex value For WEP128, the key is 10 hex characters long; for WEP128, the key is 26 hex characters long; the default value is null. Format: <pre>SET NW KEYVAL &lt;key&gt;</pre>



**Table 34 Network Commands**

Command	Description
SET NW MOde	Sets WLAN mode The possible modes are Infrastructure and Ad-Hoc; the default value is Ad-Hoc Format: <code>SET NW MOde &lt;mode&gt;</code>
SH NW MODE	Shows wireless operating mode Sample output: <code>Wifi mode = AD-HOC (802.11)</code>
SH NW RADio	Shows the selected radio mode of operation Sample output: <code>Radio mode is 802.11b-g</code>
SET NW SSid	Sets WLAN SSID The default value is <i>serserv</i> . Format: <code>SET NW SSid &lt;name&gt;</code>
CL NW SSid	Clears SSID value and allows the server to connect to any AP. Format: <code>CL NW SSid</code>
SET NW BGSCAN	Sets WLAN background scan interval in seconds. Defaults to 60 seconds. Format: <code>SET NW BGSCAN &lt;value&gt;</code>
SH NW BGSCAN	Shows the WLAN background scan interval Format: <code>SH NW BGSCAN</code>
SET NW RTS	Sets WLAN RTS threshold The possible values are between 1 and 3000; the default value is 2432. Format: <code>SET NW RTS n</code>
SH NW RTS	Shows wireless RTS threshold Sample output: <code>Wifi RTS Threshold = 2432</code>
SET NW SCAN <list> ENA/DIS	Sets WLAN list of channels to scan Format: <code>SET NW SCAN 2,3,4,5,7,8,9,10 DIS</code>
SH NW REGDOM	Show regulatory domain setting

**Table 34 Network Commands**

Command	Description
SET NW REGDOM <dom>	<p>Sets the regulatory domain for the unit. This controls which channels are available to be scanned in the 2.4GHz band. For US, channels 1-11 are available, for DE (Europe) channels 1-13 are available, and for JP channels 1-14 are available. The default is US.</p> <p>Format:</p> <pre>SET NW REGDOM &lt;US   DE   JP&gt;</pre>
SH NW STATS	<p>Shows network I/O statistics</p> <p>Sample output:</p> <pre>WiFi statistics: Roam count = 2</pre>
SET NW ID	<p>Sets authentication User ID</p> <p>This can include the realm separated by @.</p> <p>The default value is anonymous.</p> <p>Sample output:</p> <pre>SET NW ID &lt;user id&gt;</pre>
SH NW ID	<p>Shows the value of the authentication ID, including realm, if applicable</p> <p>The default realm is a null (blank) string.</p> <p>The deprecated command SH NW TTID also returns this data.</p> <p>Sample output:</p> <pre>anonymous@somewhere</pre>
SET NW PW	<p>Sets the password for the 802.1x EAP authentication, if enabled</p> <p>The default value is anonymous.</p> <p>Format:</p> <pre>SET NW PW &lt;password&gt;</pre>
SET NW INAP	<p>Sets EAP inner-authentication protocol</p> <p>The possible protocols are PAP and MSCHAP_V2; the default value is PAP.</p> <p>Format:</p> <pre>SET NW INAP [PAP MSCHAP_V2]</pre>
SH NW INAP	<p>Shows the inner authentication mode</p> <p>The deprecated command SH NW TTAP also returns this data.</p> <p>Sample output:</p> <pre>Authentication protocol = PAP</pre>
SET NW REALM	<p>Sets the realm portion of the 802.1x EAP authentication ID</p> <p>This value can also be set with the ID command.</p> <p>The default value is null.</p> <p>Format:</p> <pre>SET NW REALM &lt;realm&gt;</pre>

<b>Table 34 Network Commands</b>	
<b>Command</b>	<b>Description</b>
SH NW REALM	Shows the realm associated with the authentication ID, if applicable. The default value is null (blank) string. The deprecated command SH NW TTRE also returns this data. Sample output: Somewhere
SET NW WPAGROUP	Enable or disable WPA group key mode. If enabled, group keys can be used for data link encryption. The default value is disabled. Sample output: SET NW WPAGROUP [ENABLE   DISABLE]
SH NW WPAAUTO	Shows state of WPA auto connect flag Sample output: WPA-AUTO Enabled
SH NW WPAGROUP	Shows state of the allow WPA group keys flag Sample output: WPA-GROUP Disabled.
SET NW WPAPSK	Sets WPA PSK pass phrase or hex key. This value is only used if the authentication mode is WPA-PSK or WPA2-PSK. The argument to this command is either a pass phrase of 8 to 63 characters or exactly 64 hex characters representing the 256 bit PSK value. Format: SET NW WPAPSK <key>
SET NW RESET*	This command stops, and then resets the wireless network interface. This will effectively disassociate the unit from an access point if it is connected. If the unit is in wireless infrastructure mode, the unit will then scan and attempt to reconnect to a suitable access point, if one is available.  Format: SET NW RESET

\*Not implemented in early releases of SX-560 firmware.

## Port Commands

Note: Examples shown are for Serial Port (S1). To use the commands with Serial Port 2 (S2), substitute the port name S2 instead of S1 in the command

Table 35 Port Commands	
Command	Description
SH PORT	Shows port parameters Sample output: <pre> Port      Q-Size   Type      Attributes *S1      0        serial    115200 N 8 1 XON/XOFF </pre>
CLEAR PORT S1 JOB	Aborts the active job on the port. If the remote host is connected, additional data received will be discarded. Format: <pre>CL PORT S1 JOB</pre>
SET PORT S1 FLOW	Sets serial port flow control to NONE, XON/XOFF, CTS, or DSR The default value is none. Format: <pre>SET PORT S1 FLOW &lt;flow&gt;</pre>
SET PORT S1 PARITY	Sets serial port parity to NONE, EVEN, ODD, MARK, or SPACE The default value is none. Format: <pre>SET PORT S1 Parity &lt;parity&gt;</pre>
SET PORT S1 SIZE	Sets data bits on the serial port The default value is 8. Format: <pre>SET PORT S1 SIZE [7   8]</pre>
SET PORT S1 SPEED	Sets serial port baud rate. Options for speed are 300, 600, 1200, 2400, 7200, 9600, 19200, 38400, 57600, 115200, 230400, 460800, 921600 The default value is 115200. Format: <pre>SET PORT S1 SPEED &lt;baudrate&gt;</pre>

Table 35 Port Commands	
Command	Description
SET PORT S1 STOP	Sets serial port stop bits per character The default value is 1. Format: <code>SET PORT S1 STOP [1   2]</code>
SET PORT S1 LATENCY	Sets serial port latency value in ms. The default value is 25ms. Format: <code>SET PORT S1 LATency &lt;ms&gt;</code>

## Server Information Commands

Table 36 Server Information Commands	
Command	Description
SET SERVER Description	Sets server description string Format: <code>SET SERVER Description &lt;description-string&gt;</code>
SET SERVER NAmE	Sets server node name The default value is TWC_XXXXXX, where XXXXXX are the last 6 hex digits of the MAC address. Format: <code>SET SERVER Name &lt;name&gt;</code>
SH SERIAL	Displays serial number of the unit Sample output: <code>Serial number is 9047595</code>
SH SERVER	Shows server parameters Sample output: <code>Serial Server Serial # 9047595 Address: 00-40-17-8A-0E-2B Name: TWC_8A0E2B Number: 0 Identification: Network Server Enabled Characteristics: Link DOWN</code>
SH SERVER CO	Shows server network statistics Sample output:

Table 36 Server Information Commands	
Command	Description
	<p>Seconds Since Zeroed: 163      Frames Sent,1 Collision: 26</p> <p>Bytes Received:72950      Frames Sent, 2+Collision: 5</p> <p>Bytes Sent:18726      Send Failures: 0</p> <p>Frames Received:752      Send Failure Reasons: 0</p> <p>Frames Sent: 181      Receive Failures: 503</p> <p>Multicast Bytes Rcv'd:64474      Receive Failure Reasons: 1</p> <p>Multicast Bytes Sent: 2406      Unrecognized Destination: 0</p> <p>Multicast Frames Rcv'd:626      Data Overrun: 0</p> <p>Multicast Frames Sent:11      User Buffer Unavailable:0</p> <p>Frames Sent, Deferred:2014      System Buffer Unavailable:1</p>
SH VErSION	<p>Shows firmware version of print server</p> <p>Protocols supported: NetBIOS SNMP TCP/IP DHCP</p> <p>Sample output:</p> <pre> serial server Firmware Ver. 4.19 (2004.10.31) Boot Ver. 1.4 16Mbit Flash </pre>
Zero	Clears and resets the network and serial port statistical counters

## Service Commands

Table 37 Service Commands	
Command	Description
SET SERVI <service name> BOT	<p>Sets beginning of transmission (BOT) string index for service</p> <p>The SH SERVI STRings command displays the available strings and their associated number; the default value is 1.</p> <p>Format:</p> <pre> SET SERVI &lt;service name&gt; BOT nn </pre>
SET SERVI <service name> EOT	<p>Sets end of transmission (EOT) string index for service</p> <p>The SH SERVI STRings command displays the available strings and their associated number; the default value is 1.</p> <p>Format:</p> <pre> SET SERVI &lt;service name&gt; EOT nn </pre>
SH SERVI STRings [string_num]	<p>Displays the BOT and EOT strings used in services</p> <p>If <i>string_num</i> is provided, then the specific string definition and expansion display.</p>

**Table 37 Service Commands**

Command	Description																					
	<p>If <i>string_num</i> is not provided, then all string definitions display without their expansions.</p> <p>Sample Output:</p> <pre>10: \FF\04\FF\05\FF\06\FF\08</pre>																					
SET SERVI <service name> Filter	<p>Sets filter index for service</p> <p>Format:</p> <pre>SET SERVI &lt;service name&gt; Filter nn</pre>																					
SH SERVI FILters	<p>Shows filter settings</p> <p>Sample output:</p> <table border="1"> <thead> <tr> <th>#</th> <th>Service Name</th> <th>Filter</th> </tr> </thead> <tbody> <tr> <td>1</td> <td>TWC_FFFFFFFF</td> <td>0: No Filter</td> </tr> <tr> <td>2</td> <td>BINARY_P1</td> <td>0: No Filter</td> </tr> <tr> <td>3</td> <td>TEXT_P1</td> <td>1: Text Substitution m= LF, r= CRLF</td> </tr> <tr> <td>4</td> <td>TWC_FFFFFFFF_P1_4</td> <td>0: No Filter</td> </tr> <tr> <td>5</td> <td>TWC_FFFFFFFF_P1_5</td> <td>0: No Filter</td> </tr> <tr> <td>6</td> <td>TWC_FFFFFFFF_P1_AT</td> <td>4: PostScript Tagged Binary</td> </tr> </tbody> </table>	#	Service Name	Filter	1	TWC_FFFFFFFF	0: No Filter	2	BINARY_P1	0: No Filter	3	TEXT_P1	1: Text Substitution m= LF, r= CRLF	4	TWC_FFFFFFFF_P1_4	0: No Filter	5	TWC_FFFFFFFF_P1_5	0: No Filter	6	TWC_FFFFFFFF_P1_AT	4: PostScript Tagged Binary
#	Service Name	Filter																				
1	TWC_FFFFFFFF	0: No Filter																				
2	BINARY_P1	0: No Filter																				
3	TEXT_P1	1: Text Substitution m= LF, r= CRLF																				
4	TWC_FFFFFFFF_P1_4	0: No Filter																				
5	TWC_FFFFFFFF_P1_5	0: No Filter																				
6	TWC_FFFFFFFF_P1_AT	4: PostScript Tagged Binary																				
SET SERVI <service name> FMS	<p>Sets filter 1 text replacement match string index.</p> <p>If the index is zero, the default string of &lt;LF&gt; (line feed) is used.</p> <p>The default value is 0.</p> <p>Format:</p> <pre>SET SERVI &lt;service name&gt; FRM nn</pre>																					
SET SERVI <service name> FRS	<p>Sets filter 1 text replacement replace string index.</p> <p>If the index is zero, the default string of &lt;CRLF&gt; (carriage return-line feed) is used.</p> <p>The default value is 0.</p> <p>Format:</p> <pre>SET SERVI &lt;service name&gt; FRS nn</pre>																					
SET SERVI <service name> IP	<p>Enables or disables IP based jobs such as lpd, raw tcp and ftp, on the service</p> <p>The default value is enabled for service 1 and 2, disabled for all others.</p> <p>Format:</p> <pre>SET SERVI &lt;service name&gt; IP [ENable   DIsable]</pre>																					
SET SERVI <service name> NAME	<p>Changes service name</p> <p>The default value varies by service</p> <p>Format:</p> <pre>SET SERVI &lt;service name&gt; NAME &lt;newname&gt;</pre>																					
SET SERVI <service name> PORT	<p>Sets output port associated with a service</p> <p>The default value is S1.</p>																					

Table 37 Service Commands	
Command	Description
	Format: <pre>SET SERVI &lt;service name&gt; Port &lt;portname&gt;</pre>
SET SERVI <service name> PRIority	Sets priority for service for multiple service transmissions simultaneously The default value is 10. Format: <pre>SET SERVI &lt;service name&gt; PRIority nn</pre>
SH SERVI PRI [ <i>service_num</i> ]	Shows priority of service. If <i>service_num</i> is not provided, the priority of all services is listed.
SET SERVI <service name> RECeive	Sets receive only mode for a service This option is required only for host applications that do not operate properly if data is received from the serial device. The default value is disabled. Sample output: <pre>SET SERVI &lt;service name&gt; RECeive [ENable   Disable]</pre>
SET SERVI <service name> TCP	Sets raw TCP port for service If port number is 0, raw TCP is disabled on service. The default value is 9100 for service 1, 3001 for service 2. Format: <pre>SET SERVI &lt;service name&gt; TCP nn</pre>
SH SERVI SUMmary [ <i>service_num</i> ]	Shows the basic parameters for a specific service. If <i>service_num</i> is not provided, parameters for all services are displayed. The command SH SERVI displays the same data as SHOW SERVI SUM.

## SNMP Commands

Table 38 SNMP Commands	
Command	Description
SET SNMP GETCOMM*	Gets community name The default value is public. Format: <pre>SET SNMP GETCOMM &lt;string&gt;</pre>
SET SNMP JETADmin	Enables or disables JetAdmin compatibility The default value is enabled. Format: <pre>SET SNMP JETADmin [ ENable   Disable]</pre>
SET SNMP	Sets community 1 name



<b>Table 38 SNMP Commands</b>	
<b>Command</b>	<b>Description</b>
SETCOMM1*	The default value is internal? Format: <code>SET SNMP SETCOMM1 &lt;string&gt;</code>
SET SNMP SETCOMM2*	Sets community 2 name The default value is Pass. Format: <code>SET SNMP SETCOMM2 &lt;string&gt;</code>
SET SNMP CONTACT	Sets system contact string The default value is null. Format: <code>SET SNMP CONTACT &lt;string&gt;</code>
SET SNMP LOCATION	Sets system location string The default value is null. Format: <code>SET SNMP LOCATION &lt;string&gt;</code>
SH SNMP	Shows state of SNMP protocol enable Sample output: <code>SNMP is Enabled</code>

\*Not implemented in early releases of SX-560 firmware.

## String Commands

<b>Table 39 String Commands</b>	
<b>Command</b>	<b>Description</b>
SET STRING	Set service string table entry String 1 to11 cannot be set or changed. Format: <code>SET STRING &lt;string #&gt; "value"</code>
CL STRING	Clears the service string table entry Format: <code>CL STRING &lt;string #&gt;</code>

Table 39 String Commands	
Command	Description
SH STRing [ <i>string_num</i> ]	<p>Defines the BOT and EOT strings used in services</p> <p>If <i>string_num</i> is provided, then the specific string definition and expansion are displayed. If <i>string_num</i> is not provided, then all string definitions are displayed without their expansions.</p> <p>Sample output:</p> <pre> 1: 2: \1BE 3: \04 4: \1B%-12345X 5: @PJL 6: ENTER LANGUAGE= 7: PCL\0A 8: POSTSCRIPT\0A 9: \FF\04\FF\05\FF\06\FF\07 10: \FF\04\FF\05\FF\06\FF\08 11: \0C </pre>
SH FILters	<p>Shows the filters that can modify a job stream</p> <p>Sample output:</p> <pre> #      Filter 0      No Filter 1      Text Substitution 2      AppleTalk 3      Text to PostScript 4      PostScript Tagged Binary 5      DC1 Special </pre>

## TCP/IP Commands

Table 40 TCP/IP Commands	
Command	Description
SET IP ACcess	<p>Allows or prevents access to a block of remote addresses</p> <p>The default value is empty list.</p> <p>Format:</p> <pre> SET IP ACcess [EN   DI   ALL] aa.bb.cc.dd {MAsk ee.ff.gg.hh] </pre>

**Table 40 TCP/IP Commands**

<b>Command</b>	<b>Description</b>
SET IP RANge	Allows or prevents access to a range of remote addresses The default value is empty list. Format: <pre>SET IP RANge [EN   DI   ALL] aa.bb.cc.dd {MAx ee.ff.gg.hh}</pre>
SH IP ACcess	Displays current access list settings Sample output: <pre>All hosts permitted access</pre>
SET IP ADdress	Sets server IP address The default value is 192.0.0.192 Format: <pre>SET IP ADdress aa.bb.cc.dd</pre>
SET IP BANner	Enables or disables printing of job banner on LPD jobs The default value is Disable. Format: <pre>SET IP BANner [ENable   DIsable]</pre>
SET IP FTIme	Sets IP timeout If enabled, the IP timeout is measured in seconds. If disable, the IP timeout is in minutes. The default value is Disable. Format: <pre>SET IP FTIme [ENable   DIsable]</pre>
SET IP FTP	Enables or disables FTP protocol The default value is Enable. Format: <pre>SET IP FTP [ENable   DIsable]</pre>
SET IP HTTP	Enables or disables HTTP protocol The default value is Enable. Format: <pre>SET IP HTTP [ENable   DIsable]</pre>
SET IP KEepalive*	Sets interval in minutes for sending TCP keepalive packets on a connection The default value is 5 minutes. Format: <pre>SET IP KEepalive n</pre>
SET IP LPD	Enables or disables the LPD protocol The default value is Enable. Format: <pre>SET IP LPD [ENable   DIsable]</pre>

**Table 40 TCP/IP Commands**

<b>Command</b>	<b>Description</b>
SET IP MEthod	Sets method of getting IP address The default value is Auto. Format: <code>SET IP MEthod [ AUTO   DHCP   STATIC ]</code>
SET IP REtry	Enables or disables LPD retry on incomplete job The default value is Disable. Format: <code>SET IP REtry [ENable   DIsable]</code>
SET IP ROuter	Sets default router address The default value is 0.0.0.0. Format: <code>SET IP ROuter aa.bb.cc.dd</code>
SET IP SUBnet	Sets IP subnet mask The default value is 0.0.0.0. Format: <code>SET IP SUBnet aa.bb.cc.dd</code>
SET IP TCP	Enables or disables the raw TCP 9100 protocol The default value is Enable. Format: <code>SET IP TCP [ENable   DIsable]</code>
SET IP TELnet	Enables or disables Telnet protocol The default value is Enable. Format: <code>SET IP TELnet [ENable   DIsable]</code>
SET IP TFTP	Enables or disables TFTP protocol The default value is Enable. Format: <code>SET IP TFTP [ENable   DIsable ]</code>
SET IP TImeout	Sets TCP inactivity timeout. If fast timeout is enabled, the timeout is calculated as seconds. If fast timeout is disabled, the timeout is calculated as minutes. The default value is 1 minute. Format: <code>SET IP TImeout n</code>

**Table 40 TCP/IP Commands**

Command	Description																																																									
SH IP	<p>Shows TCP/IP related parameters</p> <p>Sample Output:</p> <pre>IP is enabled IP address      192.0.0.192      Boot tries      3 Subnet mask     0.0.0.0          Boot method     AUTO IP Gateway      0.0.0.0          Max window      10240 (set manually) LPD banner      disabled         Timeout         1 min LPD retries are disabled  Keepalive       5 min</pre> <table border="1"> <thead> <tr> <th align="left">Service</th> <th align="left">Port</th> <th align="left">TCP port</th> </tr> </thead> <tbody> <tr> <td>xxxxxx_S1_A</td> <td>S1</td> <td>9100</td> </tr> <tr> <td>xxxxxx_S1_B</td> <td>S1</td> <td>3001</td> </tr> </tbody> </table>	Service	Port	TCP port	xxxxxx_S1_A	S1	9100	xxxxxx_S1_B	S1	3001																																																
Service	Port	TCP port																																																								
xxxxxx_S1_A	S1	9100																																																								
xxxxxx_S1_B	S1	3001																																																								
SET IP TRAP n TRIG <trigger-mask>	<p>Specifies the trigger conditions that will cause a trap to be sent. &lt;trigger-mask&gt; is an integer in hex format representing a 32-bit mask as defined below. If the corresponding bit is 1, the trigger condition is enabled to cause the trap.</p> <p>NOTE: Even if the trigger bit is set by this command, no trap will be entered if the underlying trigger has not been configured.</p> <table border="1"> <thead> <tr> <th align="left">Bit#</th> <th align="left">Hex Value</th> <th align="left">Trigger Condition</th> </tr> </thead> <tbody> <tr><td>0</td><td>00000001</td><td>Serial Server: Match string 1</td></tr> <tr><td>1</td><td>00000002</td><td>Serial Server: Match string 2</td></tr> <tr><td>2</td><td>00000004</td><td>Serial Server: Match string 3</td></tr> <tr><td>3</td><td>00000008</td><td>Serial Server: Match string 4</td></tr> <tr><td>4</td><td>00000010</td><td>Serial Server: Match string 5</td></tr> <tr><td>5</td><td>00000020</td><td>Serial Server: Match string 6</td></tr> <tr><td>6</td><td>00000040</td><td>Serial Server: Match string 7</td></tr> <tr><td>7</td><td>00000080</td><td>Serial Server: Match string 8</td></tr> <tr><td>8</td><td>00000100</td><td>undefined</td></tr> <tr><td>9</td><td>00000200</td><td>undefined</td></tr> <tr><td>10</td><td>00000400</td><td>undefined</td></tr> <tr><td>11</td><td>00000800</td><td>undefined</td></tr> <tr><td>12</td><td>00001000</td><td>undefined</td></tr> <tr><td>13</td><td>00002000</td><td>undefined</td></tr> <tr><td>14</td><td>00004000</td><td>undefined</td></tr> <tr><td>15</td><td>00008000</td><td>undefined</td></tr> <tr><td>16</td><td>00010000</td><td>GPIO Trigger1: GPIO1 0 to 1</td></tr> <tr><td>17</td><td>00020000</td><td>GPIO Trigger2: GPIO2 0 to 1</td></tr> </tbody> </table>	Bit#	Hex Value	Trigger Condition	0	00000001	Serial Server: Match string 1	1	00000002	Serial Server: Match string 2	2	00000004	Serial Server: Match string 3	3	00000008	Serial Server: Match string 4	4	00000010	Serial Server: Match string 5	5	00000020	Serial Server: Match string 6	6	00000040	Serial Server: Match string 7	7	00000080	Serial Server: Match string 8	8	00000100	undefined	9	00000200	undefined	10	00000400	undefined	11	00000800	undefined	12	00001000	undefined	13	00002000	undefined	14	00004000	undefined	15	00008000	undefined	16	00010000	GPIO Trigger1: GPIO1 0 to 1	17	00020000	GPIO Trigger2: GPIO2 0 to 1
Bit#	Hex Value	Trigger Condition																																																								
0	00000001	Serial Server: Match string 1																																																								
1	00000002	Serial Server: Match string 2																																																								
2	00000004	Serial Server: Match string 3																																																								
3	00000008	Serial Server: Match string 4																																																								
4	00000010	Serial Server: Match string 5																																																								
5	00000020	Serial Server: Match string 6																																																								
6	00000040	Serial Server: Match string 7																																																								
7	00000080	Serial Server: Match string 8																																																								
8	00000100	undefined																																																								
9	00000200	undefined																																																								
10	00000400	undefined																																																								
11	00000800	undefined																																																								
12	00001000	undefined																																																								
13	00002000	undefined																																																								
14	00004000	undefined																																																								
15	00008000	undefined																																																								
16	00010000	GPIO Trigger1: GPIO1 0 to 1																																																								
17	00020000	GPIO Trigger2: GPIO2 0 to 1																																																								

**Table 40 TCP/IP Commands**

Command	Description		
	18	00040000	GPIO Trigger3: GPIO3 0 to 1
	19	00080000	GPIO Trigger4: GPIO4 0 to 1
	20	00100000	GPIO Trigger5: GPIO5 0 to 1
	21	00200000	GPIO Trigger6: GPIO6 0 to 1
	22	00400000	GPIO Trigger7: GPIO7 0 to 1
	23	00800000	GPIO Trigger8: GPIO8 0 to 1
	24	01000000	GPIO Trigger9: GPIO1 0 to 1
	25	02000000	GPIO Trigger10: GPIO2 1 to 0
	26	04000000	GPIO Trigger11: GPIO3 1 to 0
	27	08000000	GPIO Trigger12: GPIO4 1 to 0
	28	10000000	GPIO Trigger13: GPIO5 1 to 0
	29	20000000	GPIO Trigger14: GPIO6 1 to 0
	30	40000000	GPIO Trigger15: GPIO7 1 to 0
	31	80000000	GPIO Trigger16: GPIO8 1 to 0

\*Not implemented in early releases of SX-560 firmware.

## Power Configuration Commands

**Table 41 Power Configuration**

Command	Description
SET POWER LEVEL n	<p>Sets the power save mode. High power is for fastest throughput, low power is for lowest power consumption.</p> <pre>SET POWER &lt;power-level&gt;</pre> <p>Where &lt;power-level&gt; is a numeric value as follows</p> <p>0 = High Power (processor always on, never sleeps) 1 = Low Power</p> <p>A value of 0 disables processor power saving. The default value is 0.</p>
SH POWER	Shows the current power control mode.

## Miscellaneous Commands

Table 42 Miscellaneous Commands

Command	Description
SET DEFAULT	Set parameters to factory defaults
EXIT	This command exits the current configuration console session.
SH FATal	Shows fatal error log, if fatal errors exist.
CL FATal	Clears the fatal error log
INIT	Instructs the server to execute a soft reset when the next exit command is executed.
SET PAssword	Sets the server access (read) password
SET PROTECT	Sets update password to the string given.
CL PROTECT	Sets update password to <null>.
SAVE	Saves the current configuration to non-volatile memory. Without this command, the configuration is not saved unless an EXIT command is performed.
SH TEst	Sends the configuration data via ASCII to the serial port
UNPROTECT	If an update password has been defined (SET PROTECT), this command enters the password to allow configuration items to be modified. After entering this command, the server will prompt for the update password. If entered properly, the user will then be able to execute SET commands to modify the server configuration. This lasts only until the console session is terminated with an EXIT command.

## Help Commands

For help, simply enter HELP preceding the command. The correct syntax and a brief description of the commands will display. For example, when inquiring for various commands to display specific IP parameters, type HELP SHOW IP, or for commands to change specific wireless/network security parameters, type HELP SET NWRK.

## Appendix C SX-560-1701 Antenna Information

### Antenna Cable Drawings and Specifications

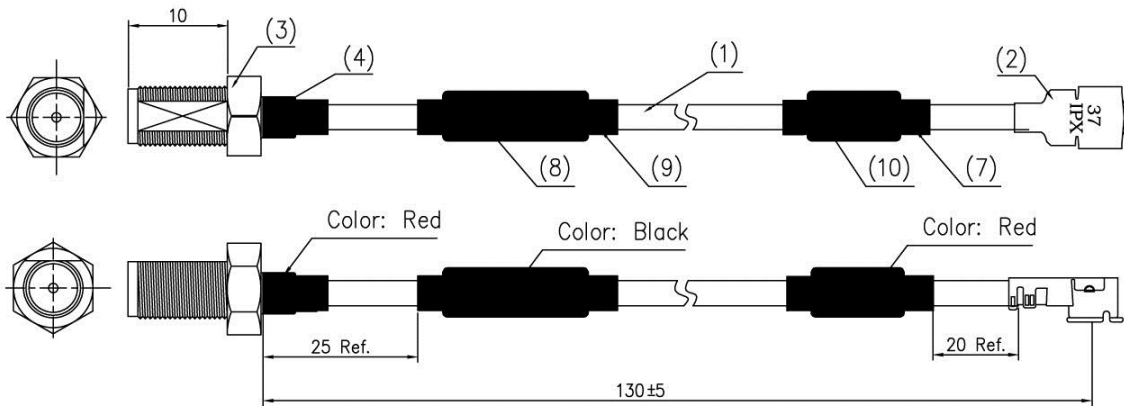

10	SHRINK TUBE (ø4) Red	1
9	SHRINK TUBE (ø6~7) BLACK	1
8	CORE OD ø6*ID ø2*L 25	1
7	CORE ø4*10*2	1
6	NUT	1
5	TOOTH WASHER	1
4	SHRINK TUBE (ø3.0~3.5) Red	1
3	RP-SMA-JACK (10mm) Blk Special	1
2	I-PEX PLUG (20351-111R-37)	1
1	COAXIAL CABLE ø1.37 White	1

**Figure 18 Antenna Cable Assembly**



**Table 43 Electrical Performance**

Parameter	Value
Impedance	50 ohms
Frequency Range	1 to 6 GHz
Working Voltage	500 VAC (rms) maximum
Dielectric Withstanding Voltage	1000 VAC (rms) maximum
Insulator Resistance	1000 megohms minimum

**Antenna Drawings and Specifications**

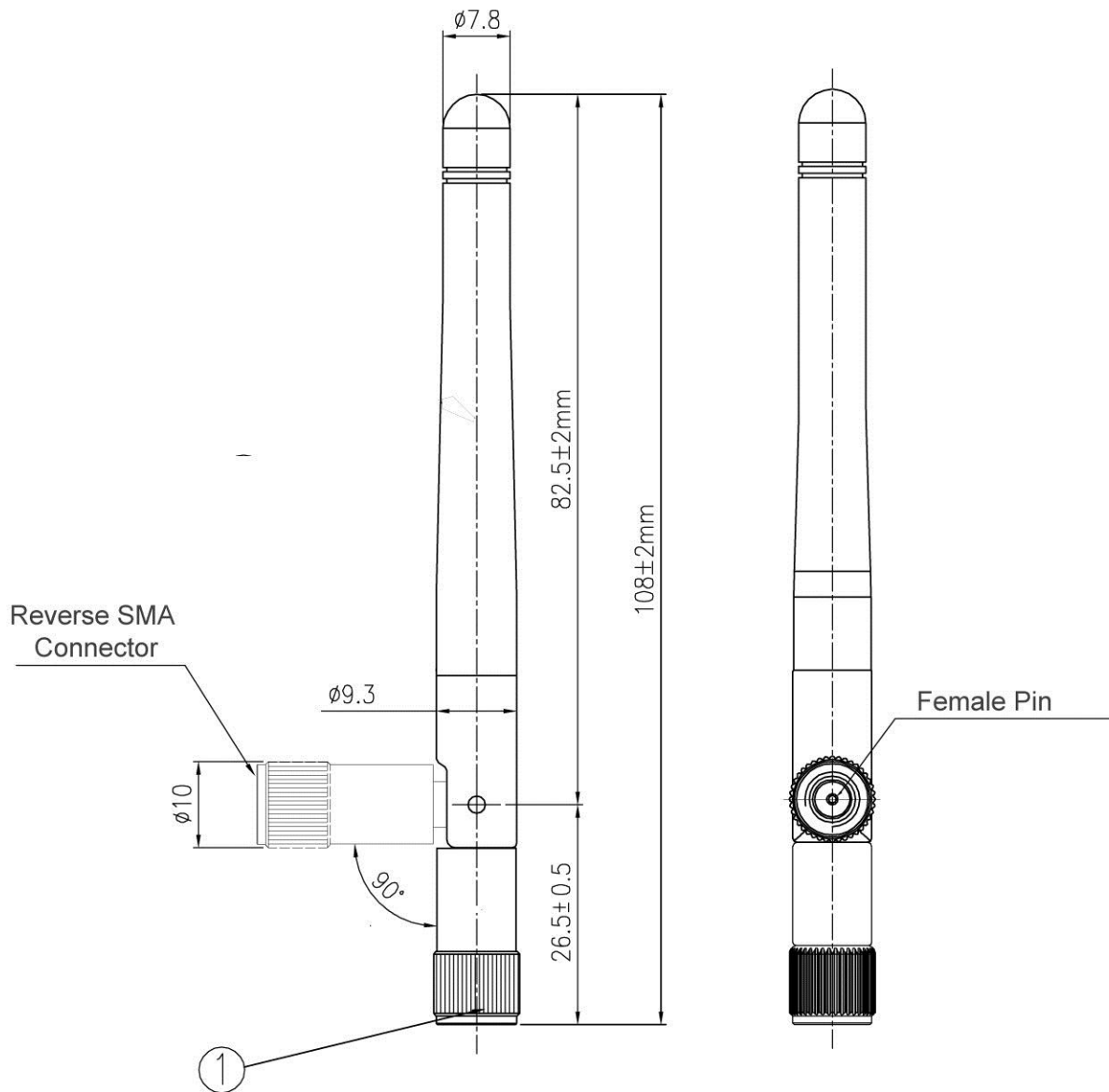

**Figure 28 Antenna Mechanical Drawing**

**Table 44 Electrical Specifications**

<b>Parameter</b>	<b>Value</b>
Antenna Type	Dipole Swivel Antenna
Frequency Range	2.4 to 5.8 GHz
Impedance	50 Ohms
Gain	2.4 GHz < 1.5 dBi 5.825 GHz < 2.1 dBi
VSWR	≤ 2.0
Admitted Power Radiation	Omni
Polarization	Vertical
Electrical Length	¼ n Dipole
Standard Connector	SMA — male reverse

## Appendix D

# SX-560-2701 Antenna Information

### Antenna Specifications

Recommended antennas are from Ethertronics and Pulse Engineering.

Please refer to the Ethertronics website @ [www.ethertronics.com](http://www.ethertronics.com) for more detailed information for the Prestta WLAN Embedded Antenna, Part No. 1000418.  
This part is available from Silex (PN #108-00019-050).

**Table 43 Electrical Specifications**

Parameter	Value
Antenna Type	Isolated Magnetic Dipole
Frequency Range	2.4 to 5.8 GHz
Impedance	50 Ohms
Gain (peak)	2.4 GHz = 2.5 dBi 5.8 GHz = 3.5 dBi
VSWR	≤ 2.0
Standard Connector	U.FL Micro Coaxial

Please refer to the Pulse website @ [www.pulseeng.com/antennas](http://www.pulseeng.com/antennas) for more detailed information for the Pulse Dualband WLAN Ceramic Antenna, Part No. W3006.

**Table 44 Electrical Specifications**

Parameter	Value
Antenna Type	High-Dielectric Monopole
Frequency Range	2.4 to 5.8 GHz
Impedance	50 Ohms
Gain (peak)	2.4 GHz = 3.2 dBi 5.8 GHz = 4.2 dBi
VSWR	≤ 2.0
Standard Connector	U.FL Micro Coaxial

## Appendix E

# Firmware Update Procedures

Occasionally it may be necessary to update the SX-560 to take advantage of new features or to fix specific problems. The simplest way to perform this update is with the Silex UpdateIP utility for Windows XP and 2000 computers. This utility can be found on the CD-ROM that is included with the SX-560, or it can be downloaded from the *Support & Downloads* section of the Silex website ([www.silexamerica.com](http://www.silexamerica.com)).

To use UpdateIP:

1. Download the appropriate firmware update file from the *Support & Download* section of the Silex website ([www.silexamerica.com](http://www.silexamerica.com)) into a directory on your computer.
2. Download or copy the UpdateIP software files into a directory on your computer.
3. Double click the updateip.exe icon to start the UpdateIP application.

**Important:** Make sure that the UpdateIP application is included as an exception if you have a firewall enabled on your PC.

4. Click **OK** when you get the **About Update for TCP/IP** splash screen
5. When you get the **Select Update File** screen, locate the firmware update file that you downloaded in step 1, and double click on the file name.
6. You will get the **Update Files** screen. The firmware update file that you selected should appear on this screen. Click **OK**.
7. The program will search the local network for SX-560s. Click **OK** when the search process is complete.
8. A list of available SX-560s will appear. Highlight the SX-560(s) that you wish to update.
9. From the menu bar, select **Update** and then **Start** to update the SX-560(s).

If you cannot use UpdateIP, you can use the trivial file transfer protocol (tftp) to update the Serial Device Server firmware:

1. Download the appropriate firmware update file from the *Support & Downloads* Section of the Silex website ([www.silexamerica.com](http://www.silexamerica.com)) into a directory on your computer.
2. If you are using Windows 2000, XP, or Vista, enter the following command from the command line of your operating system:

```
tftp -i ipaddress put filename access
```

where *ipaddress* is the IP address of the Serial Device Server, *filename* is the file name (and path, if necessary), and "access" is the Serial Device Server password (if you changed this password, use your new password instead of "access"). For example, to download the file

tathsti130.bin from the updates directory on your computer into a Serial Device Server with an IP address of 192.168.5.70, you would enter the command:

```
tftp -i 192.168.5.70 put /updates/tathsti130.bin access
```

If you are using a different operating system, please refer to the documentation of that operating system for information on how to use the tftp command. Note that you should specify that the tftp destination file is the Serial Device Server password (“access” by default).

## **Appendix F**

# **GNU/Linux Open Source and Programming**

The SX-560 is designed around GNU/Linux Open Source software. The source code and programming tools are available on the SX-560 web page in the Products and Services section of the Silex America website ([www.silexamerica.com](http://www.silexamerica.com)). This web page also contains documentation regarding GNU/Linux programming and the SX-560.

For assistance in programming the SX-560, you can purchase consulting time from Silex on a fixed price or hourly rate. To get details on this consulting, please contact Silex sales at 801-748-1199, or E-mail: [sales@silexamerica.com](mailto:sales@silexamerica.com)

## Appendix G

### Silex Contact Information

#### **Silex Technology America, Inc.**

www.silexamerica.com

Technical Support: [support@silexamerica.com](mailto:support@silexamerica.com)

Sales: [sales@silexamerica.com](mailto:sales@silexamerica.com)

Tel: (801) 748-1199 8:00 to 5:00 Mountain Time

Tel: (866) 765-8761 toll-free

Fax: (801) 748-0730

#### **Silex Technology Europe GmbH**

www.silexeurope.com

Tel: +49-2151 65009-0

Tel: 0800-7453938 German toll free

Email: [contact@silexeurope.com](mailto:contact@silexeurope.com)

#### **Silex Technology Beijing, Inc.**

www.silex.com.cn

Tel: +86-10-6440-3958

Email: [contact@silex.com.cn](mailto:contact@silex.com.cn)

#### **Corporate Headquarters**

##### **Silex Technology, Inc.**

www.silex.jp

Tel: +81-774-98-3781

Email: [support@silex.jp](mailto:support@silex.jp)



Silex Technology America, Inc.  
[www.silexamerica.com](http://www.silexamerica.com)



# Mouser Electronics

Authorized Distributor

Click to View Pricing, Inventory, Delivery & Lifecycle Information:

[Silex Technology:](#)

[SX-560-1701](#) [SX-560-6900](#) [SX-560-2701](#) [SX-560-2701-SP](#)